



# 2023 CANADA F.O.B. PRICE LIST

## EFFECTIVE JANUARY 4, 2023

These F.O.B. prices (in Canadian dollars) are effective January 4, 2023 to September 30, 2023 and apply to the sale of any WEBER® brand products by Weber-Stephen (Canada) company ("Weber") to an authorized retailer in Canada ("Dealers") and supersede any previous F.O.B. prices. All F.O.B. prices are subject to change by Weber for any reason with thirty (30) days written notice. Weber reserves the right to refuse to sell any products or extend credit for any reason. Weber requires that Dealers resell Weber® products to consumers at disclosed Dealer's retail location(s) and their DBAs (Doing Business As) within Canada. As a condition of sale, Weber: (i) prohibits any sales by a Dealer of Weber® products on Internet auction sites, such as eBay®, Craigslist, or Kijiji; (ii) prohibits trans-shipping of products between Dealers (or unauthorized retailers) or to locations outside of Canada; and (iii) prohibits Dealer gas conversion of stock, floor or inventory units. Any breach of these conditions of sale, as well as the Weber Terms & Conditions will result in the termination of buying privileges and other remedies, for which Weber reserves all rights. See Weber's other published policies relating to the sale of Weber products.

Although Weber may suggest retail prices, Dealers are free to determine the prices at which they will sell Weber products.

Terms: Net 30 days (Note: invoice payment terms are effective from date of shipment).

Credit Card Payments: 2.5% processing fee applicable for VISA/Master Card, 3% American Express.

Minimum Order: **Value** of \$500.00. **Quantity** is one master carton.

### Freight Prepaid:

- GTA, including all postal codes between L1A0Z1- L9Z9Z9 and M1A0Z1- M9Z9Z9. Minimum order \$3,000
- Regional Ontario, Manitoba, Saskatchewan, Quebec, New Brunswick, Nova Scotia and Prince Edward Island. Minimum order \$5,000
- Newfoundland, Alberta, and British Columbia. Minimum order \$7,000

### Freight Collect:

- YUKON, Northwest Territories, NUNAVUT, and LABRADOR

### Pick up:

- Notice and confirmation will be provided 24 hours in advance
- Pick-up schedule is Monday through Friday 8am – 3pm
- Weber reserves the right to cancel orders not picked up during allotted timeframe. Restocking fees apply

Altered or canceled Dealer orders that have been processed and/or enroute, are subject to incurred costs, which may include handling and freight fees.

20% restocking fee will be applicable for value of unused, unopened, returned product, subject to prior approval by Weber.

### Overages/Shortages/Damages:

#### Prepaid shipments:

- All shortages/damages/overages need to be noted on the "Transporters Waybill" immediately, as well as reported to Weber within 2 business days of receiving the shipment

#### Collect shipments:

- Dealer is responsible for any transportation risks including the filing, if necessary, of any claims for loss or damage with their designated carrier

*Note: Weber® gas grills offered by Weber have been tested and certified for use within Canada only. They do not meet the safety standards of other countries. Weber® gas grills may not be exported to individuals living outside Canada. Gas mixtures, gas pressures, regulators, fittings, and gas cylinders are different from country to country. Gas grills certified to Canadian standards may not be legal or safe to operate outside of Canada. Use or shipment outside of Canada will void the limited-warranty covering this grill. If you become aware that a consumer is buying a Weber® gas grill at your retail location with the intention of shipping it out of Canada, you should refuse the sale. Please direct any inquiries from consumers intending to use or ship a Weber® gas grill outside of Canada, to Weber Customer Service 1-800-446-1071.*

**WARRANTY** ..... 02

### GAS GRIDDLES

WEBER GRIDDLE ..... 03

### PELLET GRILLS

SMOKEFIRE ..... 06

### ELECTRIC GRILLS

LUMIN ..... 08

WEBER Q ..... 10

### GAS GRILLS

WEBER TRAVELER ..... 04

WEBER Q ..... 11

SPIRIT ..... 14

GENESIS ..... 17

SUMMIT ..... 22

### SMART GRILLS

SPIRIT ..... 27

GENESIS ..... 29

### PORTABLE GRILLS

SMOKEY JOE ..... 33

GO-ANYWHERE ..... 33

### CHARCOAL GRILLS

ORIGINAL KETTLE ..... 34

MASTER-TOUCH ..... 36

PERFORMER ..... 38

SUMMIT KAMADO ..... 40

SMOKERS ..... 41

RANCH KETTLE ..... 41

### ACCESSORIES

SMART ASSISTANTS ..... 42

COOKING ..... 43

WEBER CRAFTED ..... 47

PREP AND SERVE ..... 59

CARE ..... 64

REPLACEMENT PARTS ..... 71

MERCHANDISE ..... 77

**HOW WE MEASURE** ..... 81

PLEASE NOTE: AVAILABLE DATES ARE SUBJECT TO CHANGE.



# WARRANTY



## SUMMIT\* GAS GRILLS

**10 years** All components from the date of purchase when assembled and operated in accordance with the accompanying Owner's Manual, normal wear and tear excluded.

\*Summit warranty October 1, 2017 or later.



## GENESIS GAS GRILLS

**12 years** Cookbox: no rust through/burn through (2 years paint excluding fading or discoloration)  
**12 years** Lid assembly: no rust through/burn through (2 years paint excluding fading or discoloration)  
**10 years** Stainless steel burner tubes: no rust through/burn through  
**10 years** Stainless steel cooking grates: no rust through/burn through  
**10 years** Stainless steel FLAVORIZER BARS: no rust through/burn through  
**10 years** Porcelain-enameled cast iron cooking grates: no rust through/burn through  
**3 years** WEBER CONNECT Components  
**5 years** All remaining parts

\*WARRANTY VARIES FOR INDIVIDUAL PARTS. SEE WEBER.COM FOR DETAILS.



## SPIRIT GAS GRILLS

**10 years** Cookbox: no rust-through/burn-through (2 years on paint excluding fading or discoloration)  
**10 years** Lid assembly: no rust-through/burn-through (2 years on paint excluding fading or discoloration)  
**10 years** Stainless steel burner tubes: no rust-through/burn-through  
**5 years** Stainless steel cooking grates: no rust-through/burn-through  
**5 years** Stainless steel Flavorizer® bars: no rust-through/burn-through  
**5 years** Porcelain-enameled cast-iron cooking grates: no rust-through/burn-through  
**3 years** Electrical components (Weber Connect controller)  
**2 years** All remaining parts



## CHARCOAL GRILLS AND SMOKERS

**10 years** Bowl, lid, and center ring: no rust-through/burn-through  
**5 years** One-Touch™ cleaning system: no rust-through/burn-through  
**5 years** Stainless steel cooking grates: no rust-through/burn-through  
**5 years** Plastic components (excludes fading or discoloration)  
**2 years** All remaining parts



## SMOKEFIRE WOOD FIRED PELLET GRILLS

**5 years** Cookbox and all components not covered below  
**3 years** Electrical components (Weber Connect controller, auger motor, fan, probes)  
**3 years** Cooking grates, pellet slide, burn pot, heat baffle, pellet grate, controller bezel



## WEBER TRAVELER GAS GRILLS

**5 years** Cookbox: no rust-through/burn-through  
**5 years** Lid assembly: no rust-through/burn-through  
**3 years** Stainless steel burner tube: no rust-through/burn-through  
**3 years** Porcelain-enameled cast-iron cooking grates: no rust-through/burn-through  
**2 years** All remaining parts



## WEBER LUMIN ELECTRIC GRILLS AND WEBER Q SERIES: 1000, 2000, & 3000

**5 years** Cookbox: no rust-through/burn-through (2 years on paint excluding fading or discoloration)  
**5 years** Lid assembly: no rust-through/burn-through (2 years on paint excluding fading or discoloration)  
**5 years** Stainless steel burner tubes: no rust-through/burn-through  
**5 years** Porcelain-enameled cast-iron cooking grates: no rust-through/burn-through  
**5 years** Plastic components (excluding fading or discoloration)  
**2 years** All remaining parts



## WEBER GRIDDLE GAS GRILL

**5 years** Cookbox: no rust-through/burn-through (2 years on paint excluding fading or discoloration)  
**5 years** Hard cover assembly: no rust-through/burn-through (2 years on paint excluding fading or discoloration)  
**5 years** Stainless steel burner tubes: no rust-through/burn-through  
**5 years** Carbon Steel Cooktop: (excluding rust)  
**5 years** All remaining parts: (excluding normal wear and tear)

MAP

MSRP

## WEBER GRIDDLE G28 GAS GRILL

**43310201**

\$589.00

\$649.00

WEBER GRIDDLE G28 GAS GRILL

BLACK

LP

## MASTER CARTON: 1

H: 33.5 W: 25.35 D: 17.52 Wt: 111.95 Cu.Ft.: 8.6

## DIMENSIONS - LID CLOSED

H: 37.79 W: 53.55 D: 23.56

## DIMENSIONS - LID OPEN

H: 41.5 W: 53.5 D: 23.9



0 77924 19704 8

Available Feb 2023

NEW



COVER: 7771

- Primary cooking area: 504 sq. in
- Three stainless steel burners
- 36,000 BTU-per-hour input burners
- SNAP-JET individual burner ignition system
- Hot-rolled steel cooktop
- Aluminized steel cookbox
- Side table area: 410 sq. in
- Four Tool hooks
- Front access, pull out grease tray
- Two large wheels
- Open cart design
- Hard cover with handle and two hanging hooks
- Liquid Propane (LP)

# GRILLS

MAP

MSRP

## WEBER TRAVELER GAS GRILL

**9010001**

\$499.00

\$549.00

WEBER TRAVELER PORTABLE GAS GRILL BLACK LP

MASTER CARTON: 1

H: 14.7 W: 22.1 D: 42.7 Wt: 63 Cu.Ft.: 7.9

DIMENSIONS - LID CLOSED

H: 37.2 W: 43.6 D: 23

DIMENSIONS - LID OPEN

H: 50 W: 43.6 D: 26



COVER: 7030



COVER: 7770

**9013001**

NEW

\$579.00

\$659.00

WEBER TRAVELER GAS GRILL STEALTH LP

MASTER CARTON: 1

H: 14.7 W: 22.1 D: 42.7 Wt: 63.0 Cu.Ft.: 7.9

DIMENSIONS - LID CLOSED

H: 37.2 W: 43.6 D: 23.0

DIMENSIONS - LID OPEN

H: 50.0 W: 43.6 D: 26.0



Available now

- Total cooking area = 320 square inches
- One stainless steel burner
- 13,000 BTU-per-hour input main burner
- Porcelain-enameled, cast-iron cooking grates
- Push button ignition
- Infinite control burner valve
- Porcelain enameled steel lid and cookbox
- Integrated steel folding cart
- One hand set-up and fold with automatic lid lock
- Rigid, large side table
- Built-in lid thermometer
- Two rubberized outer wheels
- Removable catch pan
- Uses disposable 16 oz. LP cylinder (sold separately)

**9020001**

NEW

\$579.00

\$659.00

WEBER TRAVELER GAS GRILL DEEP OCEAN BLUE LP

MASTER CARTON: 1

H: 14.7 W: 22.1 D: 42.7 Wt: 63.0 Cu.Ft.: 7.9

DIMENSIONS - LID CLOSED

H: 37.2 W: 43.6 D: 23.0

DIMENSIONS - LID OPEN

H: 50.0 W: 43.6 D: 26.0



Available now

**9030001**

NEW

\$579.00

\$659.00

WEBER TRAVELER GAS GRILL RED LP

MASTER CARTON: 1

H: 14.7 W: 22.1 D: 42.7 Wt: 63.0 Cu.Ft.: 7.9

DIMENSIONS - LID CLOSED

H: 37.2 W: 43.6 D: 23.0

DIMENSIONS - LID OPEN

H: 50.0 W: 43.6 D: 26.0



Available now

MAP

MSRP

## WEBER TRAVELER RV GAS GRILL

9011701

\$549.00

\$629.00

WEBER TRAVELER RV PORTABLE GAS GRILL BLACK

LP

## MASTER CARTON: 1

H: 14.7 W: 22.1 D: 42.7 Wt: 63 Cu.Ft.: 7.9

## DIMENSIONS - LID CLOSED

H: 37.2 W: 43.6 D: 23

## DIMENSIONS - LID OPEN

H: 50 W: 43.6 D: 26

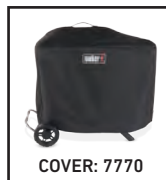

- Total cooking area = 320 square inches
- One stainless steel burner
- 13,000 BTU-per-hour input main burner
- Porcelain-enameled, cast-iron cooking grates
- Push button ignition
- Infinite control burner valve
- Porcelain enameled steel lid and cookbox
- Integrated steel folding cart
- One hand set-up and fold with automatic lid lock
- Rigid, large side table
- Built-in lid thermometer
- Two rubberized outer wheels
- Removable catch pan
- Designed to work with the RV LP system ONLY (RV version is NOT compatible with small disposable canisters)

# WOOD PELLET GRILLS

MAP

MSRP

## SMOKEFIRE EX4 WOOD FIRED PELLET GRILL (2ND GEN)

22510201

\$1399.99

\$1,499.00

SMOKEFIRE EX4 WOOD PELLET GRILL BLACK

MASTER CARTON: 1

H: 31.3 W: 43.5 D: 30.3 Wt: 176 Cu.Ft.: 23.8

DIMENSIONS - LID CLOSED

H: 47 W: 43 D: 33

DIMENSIONS - LID OPEN

H: 62 W: 43 D: 33



COVER: 7190

- Dual grilling space = 672 sq in
- Bottom grate 432 sq in, Top grate 240 sq in
- 200°-600°F temperature range
- SmokeBoost
- **WEBER CONNECT** smart grilling technology:
  - Step-by-step grilling assistance
  - Flip & serve notifications
  - Remote Grill Control and Monitoring
  - Remote Grill Shut Down
  - Diagnostic Alerts
- LCD display
- Includes two meat probes, four probe capacity
- Porcelain-enameled lid and cookbox
- Stainless steel **FLAVORIZER** bars
- High capacity hopper
- Low Fuel Sensor
- Plated steel cooking grates
- Large stainless steel side table with tool hooks
- Porcelain-enamel heat distribution plate
- Includes two additional glow plugs
- Heavy-duty steel cart frame
- Four swivel casters (2 locking, 2 non-locking)

## SMOKEFIRE EX6 WOOD FIRED PELLET GRILL (2ND GEN)

23510201

\$1,699.00

\$1,799.00

SMOKEFIRE EX6 WOOD PELLET GRILL BLACK

MASTER CARTON: 1

H: 31.3 W: 55.5 D: 30.3 Wt: 204 Cu.Ft.: 30.4

DIMENSIONS - LID CLOSED

H: 47 W: 55 D: 33

DIMENSIONS - LID OPEN

H: 62 W: 55 D: 33



COVER: 7191

- Dual grilling space, main cooking area = 1,008 sq in
- Bottom grate 648 sq in, Top grate 360 sq in
- 200°-600°F temperature range
- SmokeBoost
- **WEBER CONNECT** smart grilling technology:
  - Step-by-step grilling assistance
  - Flip & serve notifications
  - Remote Grill Control and Monitoring
  - Remote Grill Shut Down
  - Diagnostic Alerts
- LCD display
- Includes two meat probes, four probe capacity
- Porcelain-enameled lid and cookbox
- Stainless steel **FLAVORIZER** bars
- High capacity hopper
- Low Fuel Sensor
- Plated steel cooking grates
- Large stainless steel side table with tool hooks
- Porcelain-enamel heat distribution plate
- Includes two additional glow plugs
- Heavy-duty steel cart frame
- Four swivel casters (2 locking, 2 non-locking)

MAP

MSRP

## SMOKEFIRE SEAR+ ELX4 PELLET GRILL

22722001

\$1,799.00

\$1,899.00

SMOKEFIRE SEAR+ ELX4 PELLET GRILL BLACK

MASTER CARTON: 1

H: 31.25 W: 43.5 D: 30.25 Wt: 176.0 Cu.Ft.: 23.8

DIMENSIONS - LID CLOSED

H: 47.0 W: 43.5 D: 33.0

DIMENSIONS - LID OPEN

H: 64.4 W: 51.2 D: 32.7



Available Feb 2023

NEW



COVER: 7190

- Dual grilling space = 771 sq in
- Bottom grate 432 sq in, Top grate 339 sq in
- 200°-600°F temperature range
- SmokeBoost
- **WEBER CONNECT** smart grilling technology:
  - Step-by-step grilling assistance
  - Flip & serve notifications
  - Remote Grill Control and Monitoring
  - Remote Grill Shut Down
  - Diagnostic Alerts
- LCD display
- **WEBER CRAFTED** Outdoor Kitchen Collection frame
- **WEBER CRAFTED** Outdoor Kitchen Collection sear grate
- Extra-large folding top rack
- Illuminated control knob
- Top rack grate hooks
- Large black side table with tool hooks and grate hooks
- Includes two meat probes, four probe capacity
- Porcelain-enameled lid and cookbox
- Stainless steel **FLAVORIZER** bars
- High capacity 20 lb hopper
- Low Fuel Sensor
- Plated steel cooking grates
- Porcelain-enamel heat distribution plate
- Includes two glow plugs
- Heavy-duty steel cart frame
- Four swivel casters (2 locking, 2 non-locking)

## SMOKEFIRE SEAR+ ELX6 PELLET GRILL

23722001

\$2,099.00

\$2,199.00

SMOKEFIRE SEAR+ ELX6 PELLET GRILL BLACK

MASTER CARTON: 1

H: 31.25 W: 55.5 D: 30.25 Wt: 204.0 Cu.Ft.: 30.4

DIMENSIONS - LID CLOSED

H: 47.0 W: 55.5 D: 33.0

DIMENSIONS - LID OPEN

H: 64.4 W: 63.2 D: 32.7



Available Feb 2023

NEW



COVER: 7191

- Dual grilling space, main cooking area = 1,156 sq in
- Bottom grate 648 sq in, Top grate 508 sq in
- 200°-600°F temperature range
- SmokeBoost
- **WEBER CONNECT** smart grilling technology:
  - Step-by-step grilling assistance
  - Flip & serve notifications
  - Remote Grill Control and Monitoring
  - Remote Grill Shut Down
  - Diagnostic Alerts
- LCD display
- **WEBER CRAFTED** Outdoor Kitchen Collection frame
- **WEBER CRAFTED** Outdoor Kitchen Collection sear grate
- Extra-large folding top rack
- Illuminated control knob
- Top rack grate hooks
- Large black side table with tool hooks and grate hooks
- Includes two meat probes, four probe capacity
- Porcelain-enameled lid and cookbox
- Stainless steel **FLAVORIZER** bars
- High capacity 20 lb hopper
- Low Fuel Sensor
- Plated steel cooking grates
- Porcelain-enamel heat distribution plate
- Includes two glow plugs
- Heavy-duty steel cart frame
- Four swivel casters (2 locking, 2 non-locking)

# ELECTRIC GRILLS

MAP

MSRP

## LUMIN COMPACT ELECTRIC GRILL

**91010901**

\$559.00

\$619.00

LUMIN COMPACT ELECTRIC GRILL

BLACK

MASTER CARTON: 1

H: 11.65 W: 16.6 D: 20.9 Wt: 35.75 Cu.Ft.: 2.3

DIMENSIONS - LID CLOSED

H: 11.0 W: 23.0 D: 16.5

DIMENSIONS - LID OPEN

H: 22.5 W: 23.0 D: 18.0



0 77924 19070 4

Available Dec 2022

**91300901**

\$599.00

\$659.00

LUMIN COMPACT ELECTRIC GRILL

DEEP OCEAN BLUE

MASTER CARTON: 1

H: 11.65 W: 16.6 D: 20.9 Wt: 35.75 Cu.Ft.: 2.3

DIMENSIONS - LID CLOSED

H: 11.0 W: 23.0 D: 16.5

DIMENSIONS - LID OPEN

H: 22.5 W: 23.0 D: 18.0



0 77924 19619 5

Available Dec 2022

**91280901**

\$599.00

\$659.00

LUMIN COMPACT ELECTRIC GRILL

GOLDEN YELLOW

MASTER CARTON: 1

H: 11.65 W: 16.6 D: 20.9 Wt: 35.75 Cu.Ft.: 2.3

DIMENSIONS - LID CLOSED

H: 11.0 W: 23.0 D: 16.5

DIMENSIONS - LID OPEN

H: 22.5 W: 23.0 D: 18.0



0 77924 19627 0

Available Dec 2022

**91070901**

\$599.00

\$659.00

LUMIN COMPACT ELECTRIC GRILL

SEAFOAM GREEN

MASTER CARTON: 1

H: 11.65 W: 16.6 D: 20.9 Wt: 35.75 Cu.Ft.: 2.3

DIMENSIONS - LID CLOSED

H: 11.0 W: 23.0 D: 16.5

DIMENSIONS - LID OPEN

H: 22.5 W: 23.0 D: 18.0



0 77924 19623 2

Available Dec 2022

**91400901**

\$599.00

\$659.00

LUMIN COMPACT ELECTRIC GRILL

ICE BLUE

MASTER CARTON: 1

H: 11.65 W: 16.6 D: 20.9 Wt: 35.75 Cu.Ft.: 2.3

DIMENSIONS - LID CLOSED

H: 11.0 W: 23.0 D: 16.5

DIMENSIONS - LID OPEN

H: 22.5 W: 23.0 D: 18.0



0 77924 19621 8

Available Dec 2022

NEW



COVER: 7197

- Total cooking area = 178 square inches
- Reaches over 600°F (315°C) and gets to 500°F in 15 mins
- Sear, smoke, steam or boil (with a purchase of versatility kit)
- Keep food warm for hours
- Thaw frozen food while preheating
- Available in a variety of colors: deep ocean blue, seafoam green, golden yellow, ice blue, and black
- Power = 100 V
- Porcelain-Enameled, Cast-Iron Cooking Grates
- Porcelain-Enameled lid
- Ceramic burners
- 6 ft power cord



MAP

MSRP

## LUMIN ELECTRIC GRILL

**92010901** \$629.00 \$689.00

LUMIN ELECTRIC GRILL BLACK

MASTER CARTON: 1

H: 13.0 W: 19.65 D: 23.55 Wt: 46.65 Cu.Ft.: 3.5

DIMENSIONS - LID CLOSED

H: 12.0 W: 26.0 D: 19.0

DIMENSIONS - LID OPEN

H: 25.5 W: 25.5 D: 21.0



Available Dec 2022

NEW



COVER: 7197

- Total cooking area = 237 square inches
- Reaches over 600°F (315°C) and gets to 500°F in 15 mins
- Sear, smoke, steam or boil (with a purchase of versatility kit)
- Keep food warm for hours
- Thaw frozen food while preheating
- Available in a variety of colors: deep ocean blue, seafoam green, golden yellow, ice blue, and black
- Power = 120 V
- Porcelain-Enameled, Cast-Iron Cooking Grates
- Porcelain-Enameled lid
- Ceramic burners
- 6 ft power cord

**92300901** \$669.00 \$739.00

LUMIN ELECTRIC GRILL DEEP OCEAN BLUE

MASTER CARTON: 1

H: 13.0 W: 19.65 D: 23.55 Wt: 46.65 Cu.Ft.: 3.5

DIMENSIONS - LID CLOSED

H: 12.0 W: 26.0 D: 19.0

DIMENSIONS - LID OPEN

H: 25.5 W: 25.5 D: 21.0



Available Dec 2022

**92280901** \$669.00 \$739.00

LUMIN ELECTRIC GRILL GOLDEN YELLOW

MASTER CARTON: 1

H: 13.0 W: 19.65 D: 23.55 Wt: 46.65 Cu.Ft.: 3.5

DIMENSIONS - LID CLOSED

H: 12.0 W: 26.0 D: 19.0

DIMENSIONS - LID OPEN

H: 25.5 W: 25.5 D: 21.0



Available Dec 2022

**92070901** \$669.00 \$739.00

LUMIN ELECTRIC GRILL SEAFOAM GREEN

MASTER CARTON: 1

H: 13.0 W: 19.65 D: 23.55 Wt: 46.65 Cu.Ft.: 3.5

DIMENSIONS - LID CLOSED

H: 12.0 W: 26.0 D: 19.0

DIMENSIONS - LID OPEN

H: 25.5 W: 25.5 D: 21.0



Available Dec 2022

**92400901** \$669.00 \$739.00

LUMIN ELECTRIC GRILL ICE BLUE

MASTER CARTON: 1

H: 13.0 W: 19.65 D: 23.55 Wt: 46.65 Cu.Ft.: 3.5

DIMENSIONS - LID CLOSED

H: 12.0 W: 26.0 D: 19.0

DIMENSIONS - LID OPEN

H: 25.5 W: 25.5 D: 21.0



Available Dec 2022

# ELECTRIC GRILLS

MAP

MSRP

## WEBER Q 1400 ELECTRIC GRILL

52020001

\$439.00

\$479.00

WEBER Q 1400 ELECTRIC GRILL

DARK GRAY

MASTER CARTON: 1

H: 16.8 W: 28.3 D: 16.3 Wt: 28 Cu.Ft.: 4.4

DIMENSIONS - LID CLOSED

H: 14.5 W: 27 D: 16.5

DIMENSIONS - LID OPEN

H: 23.5 W: 27 D: 20.5



- Total cooking area = 189 square inches
- Porcelain-enameled, cast-iron cooking grates
- 1,560 watts - 120 volts
- Infinite heat control settings
- Aluminum heat retention liners
- Cast aluminum lid and body
- Glass-reinforced nylon frame
- Removable catch pan
- 6-foot grounded cord

## WEBER Q 2400 ELECTRIC GRILL

55020001

\$529.00

\$579.00

WEBER Q 2400 ELECTRIC GRILL

DARK GRAY

MASTER CARTON: 1

H: 17 W: 32.5 D: 18.3 Wt: 43 Cu.Ft.: 6

DIMENSIONS - LID CLOSED

H: 14.5 W: 31.5 D: 19.5

DIMENSIONS - LID OPEN

H: 26 W: 31.5 D: 25.1



- Total cooking area = 280 square inches
- Porcelain-enameled, cast-iron cooking grates
- 1,560 watts - 120 volts
- Infinite heat control settings
- Aluminum heat retention liners
- Cast aluminum lid and body
- Glass-reinforced nylon frame
- Removable catch pan
- 6-foot grounded cord

MAP

MSRP

## WEBER Q 1000 GAS GRILL

**50060001**

\$269.00

\$299.00

WEBER Q 1000 GAS GRILL

TITANIUM

LP

MASTER CARTON: 1

H: 16.8 W: 28.3 D: 16.3 Wt: 28 Cu.Ft.: 4.4

DIMENSIONS - LID CLOSED

H: 14.5 W: 27 D: 16.5

DIMENSIONS - LID OPEN

H: 23.5 W: 27 D: 20.5



0 77924 02450 4



- Total cooking area = 189 square inches
- Stainless steel burner
- 8,500 BTU-per-hour input main burner
- Porcelain-enameled, cast-iron cooking grates
- Push button ignition
- Infinite control burner valve
- Cast aluminum lid and body
- Glass-reinforced nylon frame
- Removable catch pan
- Uses disposable 14.1 or 16.4 oz. LP cylinder (sold separately)

## WEBER Q 1200 GAS GRILL

**51060001**

\$349.00

\$369.00

WEBER Q 1200 GAS GRILL

TITANIUM

LP

MASTER CARTON: 1

H: 17 W: 28 D: 16 Wt: 30 Cu.Ft.: 4.6

DIMENSIONS - LID CLOSED AND TABLES OUT

H: 15.5 W: 40.9 D: 16.5

DIMENSIONS - LID OPEN AND TABLES OUT

H: 24.6 W: 40.9 D: 20.5



0 77924 02456 6



- Total cooking area = 189 square inches
- Stainless steel burner
- 8,500 BTU-per-hour input main burner
- Porcelain-enameled, cast-iron cooking grates
- Electronic ignition
- Infinite control burner valve
- Cast aluminum lid and body
- Glass-reinforced nylon frame
- Two folding work tables
- Removable catch pan
- Built-in lid thermometer
- Uses disposable 14.1 or 16.4 oz. LP cylinder (sold separately)

**51010001**

BLACK LP



0 77924 03469 5

**51080001**

BLUE LP



0 77924 03471 8

**51190001**

ORANGE LP



0 77924 03474 9

**51040001**

RED LP



0 77924 03085 7

**51070001**

GREEN LP



0 77924 03473 2

# GAS GRILLS

MAP

MSRP

## WEBER Q 2000 GAS GRILL

53060001

\$399.00

\$429.00

WEBER Q 2000 GAS GRILL

TITANIUM

LP

MASTER CARTON: 1

H: 17 W: 32.5 D: 18.3 Wt: 43 Cu.Ft.: 5.7

DIMENSIONS - LID CLOSED AND TABLES OUT

H: 14.5 W: 51.4 D: 19.5

DIMENSIONS - LID OPEN

H: 26 W: 51.4 D: 24.3



- Total cooking area = 280 square inches
- Stainless steel burner
- 12,000 BTU-per-hour input main burner
- Porcelain-enameled, cast-iron cooking grates
- Push button ignition
- Infinite control burner valve
- Cast aluminum lid and body
- Glass-reinforced nylon frame
- Two folding work tables
- Removable catch pan
- Uses disposable 14.1 or 16.4 oz. LP cylinder (sold separately)

## WEBER Q 2200 GAS GRILL

54060001

\$419.00

\$439.00

WEBER Q 2200 GAS GRILL

TITANIUM

LP

MASTER CARTON: 1

H: 17 W: 32.5 D: 18.3 Wt: 45 Cu.Ft.: 6.0

DIMENSIONS - LID CLOSED AND TABLES OUT

H: 15.5 W: 51.4 D: 19.5

DIMENSIONS - LID OPEN AND TABLES OUT

H: 26 W: 51.4 D: 25.1



- Total cooking area = 280 square inches
- Stainless steel burner
- 12,000 BTU-per-hour input main burner
- Porcelain-enameled, cast-iron cooking grates
- Electronic ignition
- Infinite control burner valve
- Cast aluminum lid and body
- Glass-reinforced nylon frame
- Two folding work tables
- Removable catch pan
- Built-in lid thermometer
- Uses disposable 14.1 or 16.4 oz. LP cylinder (sold separately)

MAP

MSRP

## WEBER Q 3200 GAS GRILL

**57060001**

\$619.00

\$649.00

WEBER Q 3200 GAS GRILL

TITANIUM

LP

MASTER CARTON: 1

H: 21 W: 39 D: 29.3 Wt: 88 Cu.Ft.: 13.6

DIMENSIONS - LID CLOSED AND TABLES OUT

H: 43.5 W: 50.2 D: 21

DIMENSIONS - LID OPEN AND TABLES OUT

H: 55.5 W: 50.2 D: 30



0 77924 02462 7

**57067001**

\$649.00

\$699.00

WEBER Q 3200 GAS GRILL

TITANIUM

NATURAL GAS

MASTER CARTON: 1

H: 21 W: 39 D: 29.3 Wt: 88 Cu.Ft.: 13.6

DIMENSIONS - LID CLOSED AND TABLES OUT

H: 43.5 W: 50.2 D: 21

DIMENSIONS - LID OPEN AND TABLES OUT

H: 55.5 W: 50.2 D: 30



0 77924 02587 7



- Primary cooking area = 393 square inches
- Warming rack = 75 square inches
- Total cooking area = 468 square inches
- Two stainless steel burners
- 21,700 BTU-per-hour input main burners
- Porcelain-enameled, cast-iron cooking grates
- Electronic ignition
- Infinite control burner valves
- Cast aluminum lid and body
- Glass-reinforced nylon frame
- Removable folding work tables
- Built-in lid thermometer
- One handle light
- Bolts onto heavy-duty cart that includes three integrated tool hooks
- Tank holder (LP only) and storage area for tools and accessories
- Two durable all-weather wheels with full wheel hubs
- Removable catch pan
- LP gas grill includes a hose and regulator that connects to a 20 lb. LP tank (tank sold separately)
- Natural gas grill includes a 10-foot flexible hose

# GAS GRILLS

MAP

MSRP

## SPIRIT E-215 GAS GRILL

**46112001**

\$699.00

\$749.00

SPIRIT E-215 GAS GRILL

BLACK

LP

MASTER CARTON: 1

H: 25.18 W: 23.06 D: 31.93 Wt: 116 Cu.Ft.: 10.7

DIMENSIONS - LID CLOSED

H: 45.5 W: 50 D: 24

DIMENSIONS - LID OPEN

H: 63 W: 50 D: 22



COVER: 7138

- Primary cooking area = 360 square inches
- Warming rack area = 90 square inches
- Total cooking area = 450 square inches
- Two stainless steel burners
- 26,500 BTU-per-hour input main burners
- Porcelain-enameled, cast-iron cooking grates
- Stainless steel Flavorizer bars
- Electronic Crossover ignition system
- Porcelain-enameled lid with center-mounted thermometer and painted aluminum end caps
- Two stainless steel fold-down tables
- Painted enclosed steel cabinet with painted steel door
- Front access, porcelain-enameled grease tray with catch pan
- Fuel gauge - LP models only (tank not included)
- Six tool hooks
- Two heavy-duty front locking swivel casters
- Two heavy-duty back swivel casters
- Natural gas grill includes a 10-foot flexible hose

**47112001**

\$749.00

\$799.00

SPIRIT E-215 GAS GRILL

BLACK

NATURAL GAS

MASTER CARTON: 1

H: 25.98 W: 23.5 D: 32.4 Wt: 109.78 Cu.Ft.: 10.7

DIMENSIONS - LID CLOSED

H: 45.5 W: 50 D: 24

DIMENSIONS - LID OPEN

H: 63 W: 50 D: 32



## SPIRIT E-315 GAS GRILL

**46512001**

\$799.00

\$849.00

SPIRIT E-315 GAS GRILL

BLACK

LP

MASTER CARTON: 1

H: 25.18 W: 25.37 D: 31.98 Wt: 124.7 Cu.Ft.: 11.8

DIMENSIONS - LID CLOSED

H: 45.5 W: 52 D: 24

DIMENSIONS - LID OPEN

H: 63 W: 52 D: 32



COVER: 7139

- Primary cooking area = 424 square inches
- Warming rack area = 105 square inches
- Total cooking area = 529 square inches
- Three stainless steel burners
- 32,000 BTU-per-hour input main burners
- Porcelain-enameled, cast-iron cooking grates
- Stainless steel Flavorizer bars
- Electronic Crossover ignition system
- Porcelain-enameled lid with center-mounted thermometer and painted aluminum end caps
- Painted enclosed steel cabinet with painted steel door
- Front access, porcelain-enameled grease tray with catch pan
- Fuel gauge - LP models only (tank not included)
- Six tool hooks
- Two heavy-duty front locking swivel casters
- Two heavy-duty back swivel casters
- Natural gas grill includes a 10-foot flexible hose

**47512001**

\$849.00

\$899.00

SPIRIT E-315 GAS GRILL

BLACK

NATURAL GAS

MASTER CARTON: 1

H: 25.18 W: 25.37 D: 31.93 Wt: 124.7 Cu.Ft.: 11.8

DIMENSIONS - LID CLOSED

H: 45.5 W: 52 D: 24

DIMENSIONS - LID OPEN

H: 63 W: 52 D: 32



MAP

MSRP

## SPIRIT S-315 GAS GRILL

**46502001** \$899.00 \$949.00

SPIRIT S-315 GAS GRILL STAINLESS STEEL LP

MASTER CARTON: 1

H: 25.18 W: 25.37 D: 31.98 Wt: 124.7 Cu.Ft.: 11.8

DIMENSIONS - LID CLOSED

H: 45.5 W: 52 D: 24

DIMENSIONS - LID OPEN

H: 63 W: 52 D: 32



0 77924 12982 7



COVER: 7139

- Includes one meat probe, two probe capacity
- Primary cooking area = 424 square inches
- Warming rack area = 105 square inches
- Total cooking area = 529 square inches
- Three stainless steel burners
- 32,000 BTU-per-hour input main burners
- Porcelain-enameled, cast-iron cooking grates
- Stainless steel **FLAVORIZER** bars
- Electronic Crossover ignition system
- Stainless Steel lid
- Enclosed steel cabinet with stainless steel door
- Front access, porcelain-enameled grease tray with catch pan
- Fuel gauge - LP models only (tank not included)
- 2 Chrome tool hooks
- Two heavy-duty front locking swivel casters
- Two heavy-duty back swivel casters
- Natural gas grill includes a 10-foot flexible hose

**47502001** \$949.00 \$999.00

SPIRIT S-315 GAS GRILL STAINLESS STEEL NATURAL GAS

MASTER CARTON: 1

H: 25.18 W: 25.37 D: 31.98 Wt: 124.7 Cu.Ft.: 11.8

DIMENSIONS - LID CLOSED

H: 45.5 W: 52 D: 24

DIMENSIONS - LID OPEN

H: 63 W: 52 D: 32



0 77924 14634 3

## SPIRIT E-335 GAS GRILL

**46812001** \$949.00 \$999.00

SPIRIT E-335 GAS GRILL BLACK LP

MASTER CARTON: 1

H: 25.2 W: 31.9 D: 25.4 Wt: 124.7 Cu.Ft.: 11.8

DIMENSIONS - LID CLOSED

H: 45.8 W: 49.4 D: 25.8

DIMENSIONS - LID OPEN

H: 62.5 W: 49.4 D: 31.8



0 77924 19550 1

Available Jan 2023



COVER: 7139

- Primary cooking area = 424 square inches
- Secondary cooking area = 105 square inches
- Total cooking area = 529 square inches
- Three stainless steel burners
- 32,000 BTU-per-hour input main burners
- 12,000 BTU-per-hour input side burner
- 7,500 BTU-per-hour input Sear Zone burner
- Porcelain-enameled, cast-iron cooking grates
- Stainless steel **FLAVORIZER** bars
- Electronic Crossover ignition system
- Porcelain-enameled lid
- Painted enclosed steel cabinet with painted steel door
- Front access, porcelain-enameled grease tray with catch pan
- Fuel gauge - LP models only (tank not included)
- 2 Chrome tool hooks
- Two heavy-duty front locking swivel casters
- Two heavy-duty back swivel casters
- Natural gas grill includes a 10-foot flexible hose

**47812001** \$999.00 \$1,049.00

SPIRIT E-335 GAS GRILL BLACK NG

MASTER CARTON: 1

H: 25.2 W: 31.9 D: 25.4 Wt: 124.7 Cu.Ft.: 11.8

DIMENSIONS - LID CLOSED

H: 45.8 W: 49.4 D: 25.8

DIMENSIONS - LID OPEN

H: 62.5 W: 49.4 D: 31.8



0 77924 19551 8

Available Jan 2023

# GAS GRILLS

MAP

MSRP

## SPIRIT SP-335 GAS GRILL (New pricing for 2023)

**46802101**

\$1,099.00

\$1,149.00

SPIRIT SP-335 GAS GRILL

STAINLESS STEEL LP

MASTER CARTON: 1

H: 25.2 W: 31.9 D: 25.4 Wt: 125 Cu.Ft.: 11.8

DIMENSIONS - LID CLOSED

H: 45.5 W: 49.5 D: 24

DIMENSIONS - LID OPEN

H: 63 W: 49.5 D: 32



- Primary cooking area = 424 square inches
- Warming rack area = 105 square inches
- Total cooking area = 529 square inches
- Three main stainless steel burners plus an additional Sear Zone burner
- 32,000 BTU-per-hour input main burners
- 10,000 BTU-per-hour input side burner
- 7,500 BTU-per-hour input Sear burner
- 7mm Stainless Steel grates
- Stainless steel **FLAVORIZER** bars
- Electronic Crossover ignition system
- Stainless steel lid with thermometer
- Enclosed steel cabinet with stainless steel door
- Front access, porcelain-enameled grease tray with catch pan
- Fuel gauge - LP models only (tank not included)
- 2 Chrome tool hooks
- Two heavy-duty front locking swivel casters
- Two heavy-duty back swivel casters
- Natural gas grill includes a 10-foot flexible hose

**47802101**

\$1,149.00

\$1,199.00

SPIRIT SP-335 GAS GRILL

STAINLESS STEEL NATURAL GAS

MASTER CARTON: 1

H: 25.2 W: 31.9 D: 25.4 Wt: 125 Cu.Ft.: 11.8

DIMENSIONS - LID CLOSED

H: 45.5 W: 49.5 D: 24

DIMENSIONS - LID OPEN

H: 63 W: 49.5 D: 32





MAP

MSRP

## GENESIS E-325s GAS GRILL

**35310001** \$1,299.00 \$1,399.00

GENESIS E-325s GAS GRILL BLACK LP

MASTER CARTON: 1

H: 32.13 W: 30.88 D: 35.75 Wt: 162 Cu.Ft.: 20.5

DIMENSIONS - LID CLOSED

H: 48.1 W: 61.5 D: 27

DIMENSIONS - LID OPEN

H: 62.1 W: 61.5 D: 30.6



0 77924 17456 8

**37310001** \$1,349.00 \$1,449.00

GENESIS E-325s GAS GRILL BLACK NATURAL GAS

MASTER CARTON: 1

H: 32.13 W: 30.88 D: 35.75 Wt: 162 Cu.Ft.: 20.5

DIMENSIONS - LID CLOSED

H: 48.1 W: 61.5 D: 27

DIMENSIONS - LID OPEN

H: 62.1 W: 61.5 D: 30.6



0 77924 17457 5

**35320001** \$1,299.00 \$1,399.00

GENESIS E-325s GAS GRILL COPPER LP

MASTER CARTON: 1

H: 32.13 W: 30.9 D: 35.75 Wt: 188.0 Cu.Ft.: 20.5

DIMENSIONS - LID CLOSED

H: 48.1 W: 61.5 D: 27.0

DIMENSIONS - LID OPEN

H: 62.1 W: 61.5 D: 30.6



0 77924 18008 8

**37320001** \$1,349.00 \$1,449.00

GENESIS E-325s GAS GRILL COPPER NG

MASTER CARTON: 1

H: 32.13 W: 30.9 D: 35.75 Wt: 188.0 Cu.Ft.: 20.5

DIMENSIONS - LID CLOSED

H: 48.1 W: 61.5 D: 27.0

DIMENSIONS - LID OPEN

H: 62.1 W: 61.5 D: 30.6



0 77924 18009 5



COVER: 7757

- Primary cooking area = 513 square inches
- Expandable top cooking grate area = 274 square inches
- Total cooking area = 787 square inches
- Three main stainless steel burners plus an additional Sear Zone burner
- 39,000 BTU-per-hour input main burners
- 13,000 BTU-per-hour input Sear Zone
- Porcelain-enameled, cast-iron cooking grates
- Stainless steel **FLAVORIZER** bars
- Flush electronic push button ignition system, 1 AA battery included
- Porcelain-enameled lid with thermometer
- Painted steel cabinet and doors
- Metal T-bar handle
- Premium knobs provide a precise fit and finish
- Extra large prep & serve table
- Pull & clean grease management system
- One grease scraper included
- Visible front tank scale
- Tank scale fuel gauge - LP models only (tank not included)
- Six tool hooks
- 4 Metal casters with rubber tread provide extra mobility (2 front locking casters/2 back casters)
- Propane tank inside the cabinet
- Natural gas grill includes a 10-foot flexible hose

# GAS GRILLS

MAP

MSRP

## GENESIS S-325s GAS GRILL

**35300001**

\$1,499.00

\$1,599.00

GENESIS S-325s GAS GRILL

STAINLESS STEEL

LP

MASTER CARTON: 1

H: 32.13 W: 30.88 D: 35.75 Wt: 151 Cu.Ft.: 16.6

DIMENSIONS - LID CLOSED

H: 48.1 W: 61.5 D: 27

DIMENSIONS - LID OPEN

H: 62.1 W: 61.5 D: 30.6



0 77924 17458 2

**37300001**

\$1,549.00

\$1,649.00

GENESIS S-325s GAS GRILL

STAINLESS STEEL

NATURAL GAS

MASTER CARTON: 1

H: 32.13 W: 30.88 D: 35.75 Wt: 151 Cu.Ft.: 16.6

DIMENSIONS - LID CLOSED

H: 48.1 W: 61.5 D: 27

DIMENSIONS - LID OPEN

H: 62.1 W: 61.5 D: 30.6



0 77924 17459 9



COVER: 7757

- Primary cooking area = 513 square inches
- Expandable top cooking grate area = 274 square inches
- Total cooking area = 787 square inches
- Three main stainless steel burners plus an additional Sear Zone burner
- 39,000 BTU-per-hour input main burners
- 13,000 BTU-per-hour input Sear Zone
- 7mm stainless steel cooking grates
- Stainless steel **FLAVORIZER** bars
- Flush electronic push button ignition system, 1 AA battery included
- Stainless steel lid with center-mounted thermometer and stainless steel doors
- Metal T-bar handle
- Premium knobs provide a precise fit and finish
- Extra large prep & serve table
- Pull & clean grease management system
- One grease scraper included
- Visible front tank scale
- Tank scale fuel gauge - LP models only (tank not included)
- Six tool hooks
- 4 Metal casters with rubber tread provide extra mobility (2 front locking casters/2 back casters)
- Propane tank inside the cabinet
- Natural gas grill includes a 10-foot flexible hose

MAP

MSRP

## GENESIS SI-E-330 GAS GRILL

**35913501** \$1,749.00 \$1,849.00

GENESIS SI-E-330 GAS GRILL BLACK LP

MASTER CARTON: 1

H: 32.13 W: 30.88 D: 35.75 Wt:188 Cu.Ft.: 20.5

DIMENSIONS - LID CLOSED

H: 48.1 W: 61.5 D: 27

DIMENSIONS - LID OPEN

H: 62.1 W: 61.5 D: 30.6



**37913501** \$1,799.00 \$1,899.00

GENESIS SI-E-330 GAS GRILL BLACK NATURAL GAS

MASTER CARTON: 1

H: 32.13 W: 30.88 D: 35.75 Wt:188 Cu.Ft.: 20.5

DIMENSIONS - LID CLOSED

H: 48.1 W: 61.5 D: 27

DIMENSIONS - LID OPEN

H: 62.1 W: 61.5 D: 30.6



- Night time LED grill motion lighting (3 x C-type batteries)
- Smoke box with water pan
- Side storage cabinet, fits **WEBER CRAFTED** grillware
- **WEBER CRAFTED** Outdoor Kitchen Collection frame
- Primary cooking area = 513 square inches
- Expandable top cooking grate area = 274 square inches
- Total cooking area = 787 square inches
- Three main stainless steel burners plus an additional Sear Zone burner
- 39,000 BTU-per-hour input main burners
- 13,000 BTU-per-hour input Sear Zone
- Porcelain-enameled, cast-iron cooking grates
- Stainless steel **FLAVORIZER** bars
- Electronic Crossover ignition system
- Porcelain-enameled lid with thermometer
- Painted steel cabinet and doors
- Metal T-bar handle
- Premium knobs provide a precise fit and finish
- Extra large prep & serve table
- Pull & clean grease management system
- One grease scraper included
- Visible front tank scale
- Tank scale fuel gauge - LP models only (tank not included)
- Six tool hooks
- 4 Metal casters with rubber tread provide extra mobility (2 front locking casters/2 back casters)
- Propane tank inside the cabinet
- Natural gas grill includes a 10-foot flexible hose

# GAS GRILLS

MAP

MSRP

## GENESIS E-335 GAS GRILL

**35410001**

\$1,699.00

\$1,799.00

GENESIS E-335 GAS GRILL

BLACK

LP

MASTER CARTON: 1

H: 32.13 W: 30.88 D: 35.75 Wt:178 Cu.Ft.: 20.5

DIMENSIONS - LID CLOSED

H: 48.1 W: 61.5 D: 27

DIMENSIONS - LID OPEN

H: 62.1 W: 61.5 D: 30.6



- Primary cooking area = 513 square inches
- Expandable top cooking grate area = 274 square inches
- Total cooking area = 787 square inches
- Three main stainless steel burners plus an additional Sear Zone burner
- 39,000 BTU-per-hour input main burners
- 13,000 BTU-per-hour input Sear Zone
- 12,000 BTU-per-hour input Side Burner
- Porcelain-enameled, cast-iron cooking grates
- **WEBER CRAFTED** Outdoor Kitchen Collection frame
- Stainless steel **FLAVORIZER** bars
- Flush electronic push button ignition system (1 AA battery included)
- Porcelain-enameled lid with center-mounted thermometer
- Painted steel cabinet and doors
- Metal T-bar handle
- Premium knobs provide a precise fit and finish
- Side storage cabinet, fits **WEBER CRAFTED** grillware
- Pull & clean grease management system
- Visible front tank scale
- Tank scale fuel gauge - LP models only (tank not included)
- Six tool hooks
- 4 Metal casters with rubber tread provide extra mobility (2 front locking casters/2 back casters)
- Natural gas grill includes a 10-foot flexible hose

**37410001**

\$1,749.00

\$1,849.00

GENESIS E-335 GAS GRILL

BLACK

NATURAL GAS

MASTER CARTON: 1

H: 32.13 W: 30.88 D: 35.75 Wt:178 Cu.Ft.: 20.5

DIMENSIONS - LID CLOSED

H: 48.1 W: 61.5 D: 27

DIMENSIONS - LID OPEN

H: 62.1 W: 61.5 D: 30.6



## GENESIS S-335 GAS GRILL

**35400001**

\$1,849.00

\$1,949.00

GENESIS S-335 GAS GRILL

STAINLESS STEEL

LP

MASTER CARTON: 1

H: 32.13 W: 30.88 D: 35.75 Wt:172 Cu.Ft.: 20.5

DIMENSIONS - LID CLOSED

H: 48.1 W: 61.5 D: 27

DIMENSIONS - LID OPEN

H: 62.1 W: 61.5 D: 30.6



- Primary cooking area = 513 square inches
- Expandable top cooking grate area = 274 square inches
- Total cooking area = 787 square inches
- Three main stainless steel burners plus an additional Sear Zone burner
- 39,000 BTU-per-hour input main burners
- 13,000 BTU-per-hour input Sear Zone
- 12,000 BTU-per-hour input Side Burner
- 7mm stainless steel grates
- **WEBER CRAFTED** Outdoor Kitchen Collection frame
- Stainless steel **FLAVORIZER** bars
- Flush electronic push button ignition system (1 AA battery included)
- Stainless steel lid with center-mounted thermometer and stainless steel doors
- Metal T-bar handle
- Premium knobs provide a precise fit and finish
- Side storage cabinet, fits **WEBER CRAFTED** grillware
- Pull & clean grease management system
- Visible front tank scale
- Tank scale fuel gauge - LP models only (tank not included)
- Six tool hooks
- 4 Metal casters with rubber tread provide extra mobility (2 front locking casters/2 back casters)
- Natural gas grill includes a 10-foot flexible hose

**37400001**

\$1,899.00

\$1,999.00

GENESIS S-335 GAS GRILL

STAINLESS STEEL

NATURAL GAS

MASTER CARTON: 1

H: 32.13 W: 30.88 D: 35.75 Wt:172 Cu.Ft.: 20.5

DIMENSIONS - LID CLOSED

H: 48.1 W: 61.5 D: 27

DIMENSIONS - LID OPEN

H: 62.1 W: 61.5 D: 30.6



MAP

MSRP

## GENESIS E-435 GAS GRILL

**36410001** \$1,999.00 \$2,099.00

GENESIS E-435 GAS GRILL BLACK LP

MASTER CARTON: 1

H: 32.38 W: 36.07 D: 38.19 Wt:188 Cu.Ft.: 25.8

DIMENSIONS - LID CLOSED

H: 48.1 W: 68.5 D: 27

DIMENSIONS - LID OPEN

H: 62.1 W: 68.5 D: 30.6



- Primary cooking area = 646 square inches
- Expandable top cooking grate area = 348 square inches
- Total cooking area = 994 square inches
- Four main stainless steel burners plus an additional Sear Zone burner
- 48,000 BTU-per-hour input main burners
- 12,000 BTU-per-hour input Sear Zone
- 12,000 BTU-per-hour input side burner
- Porcelain-enameled, cast-iron cooking grates
- Stainless steel **FLAVORIZER** bars
- Flush electronic push button ignition system (1 AA battery included)
- Porcelain-enameled lid with center-mounted thermometer
- Painted steel cabinet and doors
- Metal T-bar handle
- Premium knobs provide a precise fit and finish
- **WEBER CRAFTED** Outdoor Kitchen Collection frame
- Pull & clean grease management system
- Visible front tank scale
- Tank scale fuel gauge - LP models only (tank not included)
- Six tool hooks
- 4 Metal casters with rubber tread provide extra mobility (2 front locking casters/2 back casters)
- Natural gas grill includes a 10-foot flexible hose

**38410001** \$2,049.00 \$2,149.00

GENESIS E-435 GAS GRILL BLACK NATURAL GAS

MASTER CARTON: 1

H: 32.38 W: 36.07 D: 38.19 Wt:188 Cu.Ft.: 25.8

DIMENSIONS - LID CLOSED

H: 48.1 W: 68.5 D: 27

DIMENSIONS - LID OPEN

H: 62.1 W: 68.5 D: 30.6



## GENESIS S-435 GAS GRILL

**36400001** \$2,199.00 \$2,299.00

GENESIS S-435 GAS GRILL STAINLESS STEEL LP

MASTER CARTON: 1

H: 32.38 W: 36.07 D: 38.19 Wt:188 Cu.Ft.: 25.8

DIMENSIONS - LID CLOSED

H: 48.1 W: 68.5 D: 27

DIMENSIONS - LID OPEN

H: 62.1 W: 68.5 D: 30.6



- Primary cooking area = 646 square inches
- Expandable top cooking grate area = 348 square inches
- Total cooking area = 994 square inches
- Four main stainless steel burners plus an additional Sear Zone burner
- 48,000 BTU-per-hour input main burners
- 12,000 BTU-per-hour input Sear Zone
- 12,000 BTU-per-hour input side burner
- 7mm Stainless Steel grates
- Stainless steel **FLAVORIZER** bars
- Flush electronic push button ignition system (1 AA battery included)
- Stainless steel lid with center-mounted thermometer and stainless steel doors
- Metal T-bar handle
- Premium knobs provide a precise fit and finish
- **WEBER CRAFTED** Outdoor Kitchen Collection frame
- Pull & clean grease management system
- Visible front tank scale
- Tank scale fuel gauge - LP models only (tank not included)
- Six tool hooks
- 4 Metal casters with rubber tread provide extra mobility (2 front locking casters/2 back casters)
- Natural gas grill includes a 10-foot flexible hose

**38400001** \$2,249.00 \$2,349.00

GENESIS S-435 GAS GRILL STAINLESS STEEL NATURAL GAS

MASTER CARTON: 1

H: 32.38 W: 36.07 D: 38.19 Wt:188 Cu.Ft.: 25.8

DIMENSIONS - LID CLOSED

H: 48.1 W: 68.5 D: 27

DIMENSIONS - LID OPEN

H: 62.1 W: 68.5 D: 30.6



# GAS GRILLS

MAP

MSRP

## SUMMIT E-470 GAS GRILL

7171001

\$3,449.00

\$3,549.00

SUMMIT E-470 GAS GRILL

BLACK

LP

MASTER CARTON: 1

H: 52 W: 38 D: 31 Wt: 245 Cu.Ft.: 35.4

DIMENSIONS - LID CLOSED

H: 51 W: 66 D: 27

DIMENSIONS - LID OPEN

H: 57 W: 66 D: 30



COVER: 7108

- Primary cooking area = 468 square inches
- Warming rack area = 112 square inches
- Total cooking area = 580 square inches
- Four stainless steel burners
- 48,800 BTU-per-hour input main burners
- 12,000 BTU-per-hour input, flush-mounted side burner
- 10,600 BTU-per-hour input **SEAR ZONE** burner
- 6,800 BTU-per-hour input smoker burner and stainless steel smoker box
- 10,600 BTU-per-hour input, rear-mounted, infrared rotisserie burner
- Tuck-Away rotisserie system with flip-up motor and separate spit and fork storage in the enclosed cart
- 9 mm diameter stainless steel rod cooking grates
- Stainless steel **FLAVORIZER** bars
- **SNAP-JET** individual burner ignition system
- Porcelain-enameled lid with thermometer, polished handle, and painted aluminum end caps
- Enclosed cabinet with painted steel doors and chrome-plated aluminum handles
- Front access, stainless steel grease tray with catch pan
- Lighted control knobs
- LED tank scale display and fuel gauge - LP models only (tank not included)
- One **GRILL 'N GO** handle light
- Six tool hooks
- Two front locking swivel casters and two back swivel casters
- Natural gas grill includes a 10-foot flexible hose

7271001

\$3,499.00

\$3,599.00

SUMMIT E-470 GAS GRILL

BLACK

NATURAL GAS

MASTER CARTON: 1

H: 52 W: 38 D: 31 Wt: 245 Cu.Ft.: 35.4

DIMENSIONS - LID CLOSED

H: 21 W: 66 D: 27

DIMENSIONS - LID OPEN

H: 57 W: 66 D: 30



## SUMMIT S-470 GAS GRILL

7170001

\$3,449.00

\$3,549.00

SUMMIT S-470 GAS GRILL

STAINLESS STEEL

LP

MASTER CARTON: 1

H: 52 W: 38 D: 31 Wt: 245 Cu.Ft.: 35.4

DIMENSIONS - LID CLOSED

H: 51 W: 66 D: 27

DIMENSIONS - LID OPEN

H: 57 W: 66 D: 30



COVER: 7108

- Primary cooking area = 468 square inches
- Warming rack area = 112 square inches
- Total cooking area = 580 square inches
- Four stainless steel burners
- 48,800 BTU-per-hour input main burners
- 12,000 BTU-per-hour input, flush-mounted side burner
- 10,600 BTU-per-hour input **SEAR ZONE** burner
- 6,800 BTU-per-hour input smoker burner and stainless steel smoker box
- 10,600 BTU-per-hour input, rear-mounted, infrared rotisserie burner
- Tuck-Away rotisserie system with flip-up motor and separate spit and fork storage in the enclosed cart
- 9 mm diameter stainless steel rod cooking grates
- Stainless steel **FLAVORIZER** bars
- **SNAP-JET** individual burner ignition system
- Stainless steel lid with thermometer, polished handle, and painted aluminum end caps
- Enclosed cabinets with stainless steel doors and chrome-plated aluminum handles
- Front access, stainless steel grease tray with catch pan
- Lighted control knobs
- LED tank scale display and fuel gauge - LP models only (tank not included)
- One **GRILL 'N GO** handle light
- Six tool hooks
- Two front locking swivel casters and two back swivel casters
- Natural gas grill includes a 10-foot flexible hose

7270001

\$3,499.00

\$3,599.00

SUMMIT S-470 GAS GRILL

STAINLESS STEEL

NATURAL GAS

MASTER CARTON: 1

H: 52 W: 38 D: 31 Wt: 245 Cu.Ft.: 35.4

DIMENSIONS - LID CLOSED

H: 51 W: 66 D: 27

DIMENSIONS - LID OPEN

H: 57 W: 66 D: 30



MAP

MSRP

## SUMMIT E-670 GAS GRILL

**7371001** \$4,199.00 \$4,299.00

**SUMMIT E-670 GAS GRILL** BLACK LP

MASTER CARTON: 1

H: 52 W: 46 D: 31 Wt: 281 Cu.Ft.: 43.1

DIMENSIONS - LID CLOSED

H: 51 W: 74 D: 27

DIMENSIONS - LID OPEN

H: 57 W: 74 D: 30



- Primary cooking area = 624 square inches
- Warming rack area = 145 square inches
- Total cooking area = 769 square inches
- Six stainless steel burners
- 60,000 BTU-per-hour input main burners
- 12,000 BTU-per-hour input, flush-mounted side burner
- 10,600 BTU-per-hour input **SEAR ZONE** burner
- 6,800 BTU-per-hour input smoker burner and stainless steel smoker box
- 10,600 BTU-per-hour input, rear-mounted, infrared rotisserie burner
- Tuck-Away rotisserie system with flip-up motor and separate spit and fork storage in the enclosed cart
- 9 mm diameter stainless steel rod cooking grates
- Stainless steel **FLAVORIZER** bars
- **SNAP-JET** individual burner ignition system
- Porcelain-enameled lid with thermometer, polished handle, and painted aluminum end caps
- Enclosed cabinet with painted steel doors and chrome-plated aluminum handles
- Front access, stainless steel grease tray with catch pan
- Lighted control knobs
- LED tank scale display and fuel gauge - LP models only (tank not included)
- Two **GRILL 'N GO** handle light
- Six tool hooks
- Two front locking swivel casters and two back swivel casters
- Natural gas grill includes a 10-foot flexible hose

**7471001** \$4,249.00 \$4,349.00

**SUMMIT E-670 GAS GRILL** BLACK NATURAL GAS

MASTER CARTON: 1

H: 52 W: 46 D: 31 Wt: 281 Cu.Ft.: 43.1

DIMENSIONS - LID CLOSED

H: 51 W: 74 D: 27

DIMENSIONS - LID OPEN

H: 57 W: 74 D: 30



## SUMMIT S-670 GAS GRILL

**7370001** \$4,199.00 \$4,299.00

**SUMMIT S-670 GAS GRILL** STAINLESS STEEL LP

MASTER CARTON: 1

H: 52 W: 46 D: 31 Wt: 281 Cu.Ft.: 43.1

DIMENSIONS - LID CLOSED

H: 51 W: 74 D: 27

DIMENSIONS - LID OPEN

H: 57 W: 74 D: 30



- Primary cooking area = 624 square inches
- Warming rack area = 145 square inches
- Total cooking area = 769 square inches
- Six stainless steel burners
- 60,000 BTU-per-hour input main burners
- 12,000 BTU-per-hour input, flush-mounted side burner
- 10,600 BTU-per-hour input **SEAR STATION** burner
- 6,800 BTU-per-hour input smoker burner and stainless steel smoker box
- 10,600 BTU-per-hour input, rear-mounted, infrared rotisserie burner
- Tuck-Away rotisserie system with flip-up motor and separate spit and fork storage in the enclosed cart
- 9 mm diameter stainless steel rod cooking grates
- Stainless steel **FLAVORIZER** bars
- **SNAP-JET** individual burner ignition system
- Stainless steel lid with thermometer, polished handle, and painted aluminum end caps
- Enclosed cabinets with stainless steel doors and chrome-plated aluminum handles
- Front access, stainless steel grease tray with catch pan
- Lighted control knobs
- LED tank scale display and fuel gauge - LP models only (tank not included)
- Two **GRILL 'N GO** handle light
- Six tool hooks
- Two front locking swivel casters and two back swivel casters
- Natural gas grill includes a 10-foot flexible hose

**7470001** \$4,249.00 \$4,349.00

**SUMMIT S-670 GAS GRILL** STAINLESS STEEL NATURAL GAS

MASTER CARTON: 1

H: 52 W: 46 D: 31 Wt: 281 Cu.Ft.: 43.1

DIMENSIONS - LID CLOSED

H: 51 W: 74 D: 27

DIMENSIONS - LID OPEN

H: 57 W: 74 D: 30



# GAS GRILLS

MAP

MSRP

## SUMMIT S-460 BUILT-IN GAS GRILL

**7160001**

\$3,799.00

\$3,899.00

**SUMMIT S-460 BUILT-IN GAS GRILL STAINLESS STEEL LP**

MASTER CARTON: 1

H: 52 W: 39 D: 31 Wt: 245 Cu.Ft.: 35.4

DIMENSIONS - LID CLOSED

H: 51 W: 34 D: 31

DIMENSIONS - LID OPEN

H: 58 W: 34 D: 31



- Primary cooking area = 468 square inches
- Warming rack area = 112 square inches
- Total cooking area = 580 square inches
- Four stainless steel burners
- 48,800 BTU-per-hour input main burners
- 10,600 BTU-per-hour input, rear-mounted, infrared rotisserie burner
- 10,600 BTU-per-hour input **SEAR ZONE** burner
- 6,800 BTU-per-hour input smoker burner and stainless steel smoker box
- 9 mm diameter stainless steel rod cooking grates
- Stainless steel **FLAVORIZER** bars
- **SNAP-JET** individual burner ignition system
- Stainless steel lid with thermometer, polished handle, and painted aluminum end caps
- Enclosed cabinet with stainless steel doors
- Front access, stainless steel grease tray with catch pan
- SlideFrame design
- Two swivel casters and two locking casters provide easy installation and serviceability; a stainless steel panel discreetly hides them until they are needed
- Lighted control knobs
- Premium cover included
- One **GRILL 'N GO** handle light

**Island not included**

**7260001**

\$3,799.00

\$3,899.00

**SUMMIT S-460 BUILT-IN GAS GRILL STAINLESS STEEL NATURAL GAS**

MASTER CARTON: 1

H: 52 W: 39 D: 31 Wt: 245 Cu.Ft.: 35.4

DIMENSIONS - LID CLOSED

H: 51 W: 34 D: 31

DIMENSIONS - LID OPEN

H: 58 W: 34 D: 31



## SUMMIT S-660 BUILT-IN GAS GRILL

**7360001**

\$4,499.00

\$4,599.00

**SUMMIT S-660 BUILT-IN GAS GRILL STAINLESS STEEL LP**

MASTER CARTON: 1

H: 52 W: 46 D: 31 Wt: 289 Cu.Ft.: 43.1

DIMENSIONS - LID CLOSED

H: 51 W: 42 D: 31

DIMENSIONS - LID OPEN

H: 58 W: 42 D: 31



- Primary cooking area = 624 square inches
- Warming rack area = 145 square inches
- Total cooking area = 769 square inches
- Six stainless steel burners
- 60,000 BTU-per-hour input main burners
- 10,600 BTU-per-hour input, rear-mounted, infrared rotisserie burner
- 10,600 BTU-per-hour input **SEAR ZONE** burner
- 6,800 BTU-per-hour input smoker burner and stainless steel smoker box
- 9 mm diameter stainless steel rod cooking grates
- Stainless steel **FLAVORIZER** bars
- **SNAP-JET** individual burner ignition system
- Stainless steel lid with thermometer, polished handle, and painted aluminum end caps
- Enclosed cabinet with stainless steel doors
- Front access, stainless steel grease tray with catch pan
- SlideFrame design
- Two swivel casters and two locking casters provide easy installation and serviceability; a stainless steel panel discreetly hides them until they are needed
- Lighted control knobs
- Premium cover included
- Two **GRILL 'N GO** handle light

**Island not included**

**7460001**

\$4,499.00

\$4,599.00

**SUMMIT S-660 BUILT-IN GAS GRILL STAINLESS STEEL NATURAL GAS**

MASTER CARTON: 1

H: 52 W: 46 D: 31 Wt: 289 Cu.Ft.: 43.1

DIMENSIONS - LID CLOSED

H: 51 W: 42 D: 31

DIMENSIONS - LID OPEN

H: 58 W: 42 D: 31





MAP

MSRP

## SUMMIT GRILL CENTER

**291101**

\$5,399.00

\$5,599.00

SUMMIT GRILL CENTER

BLACK

LP

MASTER CARTON (BOX 1): 1

H: 54 W: 30 D: 46 Wt: 310 Cu.Ft.: 42.7

MASTER CARTON (BOX 2): 1

H: 28 W: 22 D: 36 Wt: 108 Cu.Ft.: 12.9

DIMENSIONS - LID CLOSED

H: 52 W: 91 D: 27

DIMENSIONS - LID OPEN

H: 59 W: 91 D: 30



- Primary cooking area = 624 square inches
- Warming rack area = 145 square inches
- Total cooking area = 769 square inches
- Six stainless steel burners
- 60,000 BTU-per-hour input main burners
- 27,000 BTU-per-hour input, dual ring, flush-mounted side burner
- 10,600 BTU-per-hour input **SEAR ZONE** burner
- 6,800 BTU-per-hour input smoker burner and stainless steel smoker box
- 10,600 BTU-per-hour input, rear-mounted, infrared rotisserie burner
- Tuck-Away rotisserie system with flip-up motor and separate spit and fork storage
- 9 mm diameter stainless steel rod cooking grates
- Stainless steel **FLAVORIZER** bars
- **SNAP-JET** individual burner ignition system
- Two extra large stainless steel work surfaces
- Porcelain-enameled lid with thermometer, polished handle, and painted aluminum end caps
- Two enclosed cabinets with painted steel doors and chrome-plated aluminum handles
- Stainless steel control panel with cast aluminum end caps
- Enclosed tank storage area
- Four adjustable stainless steel wire shelves
- Stainless steel paper towel holder
- Eight adjustable steel legs
- Front access, stainless steel grease tray with catch pan
- Lighted control knobs
- LED tank scale display and fuel gauge (LP models only)
- Two **GRILL 'N GO** handle light
- Six tool hooks
- Natural gas grill includes a 10-foot flexible hose
- Tank not included with LP models

**292101**

\$5,399.00

\$5,599.00

SUMMIT GRILL CENTER

BLACK

NATURAL GAS

MASTER CARTON (BOX 1): 1

H: 54 W: 30 D: 46 Wt: 310 Cu.Ft.: 42.7

MASTER CARTON (BOX 2): 1

H: 28 W: 22 D: 36 Wt: 108 Cu.Ft.: 12.9

DIMENSIONS - LID CLOSED

H: 52 W: 91 D: 27

DIMENSIONS - LID OPEN

H: 59 W: 91 D: 30



# GAS GRILLS

MAP

MSRP

## SUMMIT GRILL CENTER

**291001** \$5,399.00 \$5,599.00

SUMMIT GRILL CENTER STAINLESS STEEL LP

**MASTER CARTON (BOX 1): 1**

H: 54 W: 30 D: 46 Wt: 310 Cu.Ft.: 42.7

**MASTER CARTON (BOX 2): 1**

H: 28 W: 22 D: 36 Wt: 108 Cu.Ft.: 12.9

**DIMENSIONS - LID CLOSED**

H: 52 W: 91 D: 27

**DIMENSIONS - LID OPEN**

H: 59 W: 91 D: 30



- Primary cooking area = 624 square inches
- Warming rack area = 145 square inches
- Total cooking area = 769 square inches
- Six stainless steel burners
- 60,000 BTU-per-hour input main burners
- 27,000 BTU-per-hour input, dual ring, flush-mounted side burner
- 10,600 BTU-per-hour input **SEAR ZONE** burner
- 6,800 BTU-per-hour input smoker burner and stainless steel smoker box
- 10,600 BTU-per-hour input, rear-mounted, infrared rotisserie burner
- Tuck-Away rotisserie system with flip-up motor and separate spit and fork storage
- 9 mm diameter stainless steel rod cooking grates
- Stainless steel **FLAVORIZER** bars
- **SNAP-JET** individual burner ignition system
- Two extra large stainless steel work surfaces
- Stainless steel lid with thermometer, polished handle, and painted aluminum end caps
- Two enclosed storage areas with stainless steel doors and chrome-plated aluminum handles
- Stainless steel control panel with cast aluminum end caps
- Enclosed tank storage area
- Four adjustable stainless steel wire shelves
- Stainless steel paper towel holder
- Eight adjustable steel legs
- Front access, stainless steel grease tray with catch pan
- Lighted control knobs
- LED tank scale display and fuel gauge (LP models only)
- Two **GRILL 'N GO** handle light
- Six tool hooks
- Natural gas grill includes a 10-foot flexible hose
- Tank not included with LP models

**292001** \$5,399.00 \$5,599.00

SUMMIT GRILL CENTER STAINLESS STEEL NATURAL GAS

**MASTER CARTON (BOX 1): 1**

H: 54 W: 30 D: 46 Wt: 310 Cu.Ft.: 42.7

**MASTER CARTON (BOX 2): 1**

H: 28 W: 22 D: 36 Wt: 108 Cu.Ft.: 12.9

**DIMENSIONS - LID CLOSED**

H: 52 W: 91 D: 27

**DIMENSIONS - LID OPEN**

H: 59 W: 91 D: 30



MAP

MSRP

**7561** GRILL COVER

\$109.99

\$120.99



- Protects your grill work surfaces from the elements
- Velcro straps secure cover to the grill
- Fits **SUMMIT** grill center

**MASTER CARTON: 1**

H: 2.63 W: 12.69 D: 10.25 Wt: 3.19 Cu.Ft.: 0.19

**INDIVIDUAL CARTON:**

H: 10.25 W: 12.69 D: 2.63 Wt: 3.19

**OUT OF CARTON:**

H: 29 W: 91.1 D: 21.5



MSRP

## SPIRIT EX-315 SMART GAS GRILL

46512401

\$949.00

SPIRIT EX-315 SMART GAS GRILL      BLACK      LP

**MASTER CARTON: 1**

H: 25.18    W: 25.37    D: 31.98    Wt: 124.7    Cu.Ft.: 12.6

**DIMENSIONS - LID CLOSED**

H: 45.5    W: 52    D: 24

**DIMENSIONS - LID OPEN**

H: 63    W: 52    D: 32



- Integrated **WEBER CONNECT** smart grilling technology:
  - Step-by-step grilling assistance
  - Real time food temperature monitoring
  - WiFi and Bluetooth connected for remote grill access
  - Low fuel indications on your phone
  - Integrated ambient thermometer to measure temp of the grill
- Digital LED display (plug-in)
- Includes one meat probe, two probe capacity
- Primary cooking area = 424 square inches
- Warming rack area = 105 square inches
- Total cooking area = 529 square inches
- Three stainless steel burners
- 32,000 BTU-per-hour input main burners
- Porcelain-enameled, cast-iron cooking grates
- Stainless steel **FLAVORIZER** bars
- Electronic Crossover ignition system
- Porcelain-enameled lid
- Painted enclosed steel cabinet with painted steel door
- Front access, porcelain-enameled grease tray with catch pan
- Fuel gauge - LP models only (tank not included)
- 2 Chrome tool hooks
- Two heavy-duty front locking swivel casters
- Two heavy-duty back swivel casters
- Natural gas grill includes a 10-foot flexible hose

47512401

\$999.00

SPIRIT EX-315 SMART GAS GRILL      BLACK      NATURAL GAS

**MASTER CARTON: 1**

H: 25.18    W: 25.37    D: 31.93    Wt: 124.7    Cu.Ft.: 12.6

**DIMENSIONS - LID CLOSED**

H: 45.5    W: 52    D: 24

**DIMENSIONS - LID OPEN**

H: 63    W: 52    D: 32



## SPIRIT EX-325s SMART GAS GRILL

46912401

\$999.00

SPIRIT EX-325s SMART GAS GRILL      BLACK      LP

**MASTER CARTON: 1**

H: 26    W: 32.5    D: 26.0    Wt: 122    Cu.Ft.: 12.7

**DIMENSIONS - LID CLOSED**

H: 45.8    W: 50.1    D: 25.8

**DIMENSIONS - LID OPEN**

H: 62.5    W: 50.1    D: 31.8



- Integrated **WEBER CONNECT** smart grilling technology:
  - Step-by-step grilling assistance
  - Real time food temperature monitoring
  - WiFi and Bluetooth connected for remote grill access
  - Low fuel indications on your phone
  - Integrated ambient thermometer to measure temp of the grill
- Digital LED display
- Includes one meat probe, two probe capacity
- Primary cooking area = 424 square inches
- Warming rack area = 105 square inches
- Total cooking area = 529 square inches
- Three main stainless steel burners plus an additional Sear Zone burner
- 32,000 BTU-per-hour input main burners
- 7,500 BTU-per-hour input Sear Zone
- Porcelain-enameled, cast-iron cooking grates
- Porcelain-enameled **FLAVORIZER** bars
- Electronic Crossover ignition system
- Porcelain-enameled lid
- Painted enclosed steel cabinet with painted steel door
- Front access, porcelain-enameled grease tray with catch pan
- Fuel gauge - LP models only (tank not included)
- 2 Chrome tool hooks
- Two heavy-duty front locking swivel casters
- Two heavy-duty back swivel casters
- Natural gas grill includes a 10-foot flexible hose

47912401

\$1,049.00

SPIRIT EX-325s SMART GAS GRILL      BLACK      NG

**MASTER CARTON: 1**

H: 26    W: 32.5    D: 26.0    Wt: 122    Cu.Ft.: 12.7

**DIMENSIONS - LID CLOSED**

H: 45.8    W: 50.1    D: 25.8

**DIMENSIONS - LID OPEN**

H: 62.5    W: 50.1    D: 31.8



# SMART GRILLS

MSRP

## SPIRIT SX-315 SMART GAS GRILL

46502401

\$1,049.00

SPIRIT SX-315 SMART GAS GRILL      BLACK      LP

MASTER CARTON: 1

H: 25.18    W: 25.37    D: 31.98    Wt: 124.7    Cu.Ft.: 12.6

DIMENSIONS - LID CLOSED

H: 45.5    W: 52    D: 24

DIMENSIONS - LID OPEN

H: 63    W: 52    D: 32



0 77924 16055 4

47502401

\$1,099.00

SPIRIT SX-315 SMART GAS GRILL      BLACK      NG

MASTER CARTON: 1

H: 25.18    W: 25.37    D: 31.98    Wt: 124.7    Cu.Ft.: 12.6

DIMENSIONS - LID CLOSED

H: 45.5    W: 52    D: 24

DIMENSIONS - LID OPEN

H: 63    W: 52    D: 32



0 77924 16056 1



COVER: 7139

- Integrated **WEBER CONNECT** smart grilling technology:
  - Step-by-step grilling assistance
  - Real time food temperature monitoring
  - WiFi and Bluetooth connected for remote grill access
  - Low fuel indications on your phone
  - Integrated ambient thermometer to measure temp of the grill
- Digital LED display (plug-in)
- Includes one meat probe, two probe capacity
- Primary cooking area = 424 square inches
- Warming rack area = 105 square inches
- Total cooking area = 529 square inches
- Three stainless steel burners
- 32,000 BTU-per-hour input main burners
- Porcelain-enameled, cast-iron cooking grates
- Stainless steel **FLAVORIZER** bars
- Electronic Crossover ignition system
- Stainless Steel lid
- Enclosed steel cabinet with stainless steel door
- Front access, porcelain-enameled grease tray with catch pan
- Fuel gauge - LP models only (tank not included)
- 2 Chrome tool hooks
- Two heavy-duty front locking swivel casters
- Two heavy-duty back swivel casters
- Natural gas grill includes a 10-foot flexible hose

MSRP

## GENESIS EX-325s SMART GAS GRILL

**35510001**

\$1,549.00

GENESIS EX-325s SMART GAS GRILL    BLACK    LP

MASTER CARTON: 1

H: 32.13    W: 30.88    D: 35.75    Wt: 162    Cu.Ft.: 20.5

DIMENSIONS - LID CLOSED

H: 48.1    W: 61.5    D: 27

DIMENSIONS - LID OPEN

H: 62.1    W: 61.5    D: 30.6



- Integrated **WEBER CONNECT** smart grilling technology:
  - Step-by-step grilling assistance
  - Real time food temperature monitoring
  - WiFi and Bluetooth connected for remote grill access
  - Fuel level indications on display or your phone (LP models only)
  - Integrated ambient thermometer to measure temp of the grill
- LCD display, 1 plug-in cord included and optional 5V USB-C input
- Includes one meat probe, two probe capacity
- Porcelain-enameled, cast-iron cooking grates
- Stainless steel **FLAVORIZER** bars
- Primary cooking area = 513 square inches
- Expandable top cooking grate area = 274 square inches
- Total cooking area = 787 square inches
- Three main stainless steel burners plus an additional Sear Zone burner
- 39,000 BTU-per-hour input main burners
- 13,000 BTU-per-hour input Sear burner
- Porcelain-enameled lid
- Painted steel cabinet and doors
- Metal T-bar handle
- Premium knobs provide a precise fit and finish
- Pull & clean grease management system
- Tank scale fuel gauge - LP models only (tank not included)
- Six tool hooks
- 4 Metal casters with rubber tread provide extra mobility (2 front locking casters/2 back casters)
- Natural gas grill includes a 10-foot flexible hose

**37510001**

\$1,599.00

GENESIS EX-325s SMART GAS GRILL    BLACK    NATURAL GAS

MASTER CARTON: 1

H: 32.13    W: 30.88    D: 35.75    Wt: 162    Cu.Ft.: 20.5

DIMENSIONS - LID CLOSED

H: 48.1    W: 61.5    D: 27

DIMENSIONS - LID OPEN

H: 62.1    W: 61.5    D: 30.6



## GENESIS SX-325s SMART GAS GRILL

**35500001**

\$1,699.00

GENESIS SX-325s SMART GAS GRILL    STAINLESS STEEL    LP

MASTER CARTON: 1

H: 32.13    W: 30.88    D: 35.75    Wt: 150    Cu.Ft.: 20.5

DIMENSIONS - LID CLOSED

H: 48.1    W: 61.5    D: 27

DIMENSIONS - LID OPEN

H: 62.1    W: 61.5    D: 30.6

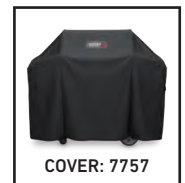

- Integrated **WEBER CONNECT** smart grilling technology:
  - Step-by-step grilling assistance
  - Real time food temperature monitoring
  - WiFi and Bluetooth connected for remote grill access
  - Fuel level indications on display or your phone (LP models only)
  - Integrated ambient thermometer to measure temp of the grill
- LCD display, 1 plug-in cord included and optional 5V USB-C input
- Includes one meat probe, two probe capacity
- 7mm Stainless Steel grates
- Stainless steel **FLAVORIZER** bars
- Primary cooking area = 513 square inches
- Expandable top cooking grate area = 274 square inches
- Total cooking area = 787 square inches
- Three main stainless steel burners plus an additional Sear Zone burner
- 39,000 BTU-per-hour input main burners
- 13,000 BTU-per-hour input Sear burner
- Stainless steel lid and doors
- Metal T-bar handle
- Premium knobs provide a precise fit and finish
- Pull & clean grease management system
- Tank scale fuel gauge - LP models only (tank not included)
- Six tool hooks
- 4 Metal casters with rubber tread provide extra mobility (2 front locking casters/2 back casters)
- Natural gas grill includes a 10-foot flexible hose

**37500001**

\$1,749.00

GENESIS SX-325s SMART GAS GRILL    STAINLESS STEEL    NATURAL GAS

MASTER CARTON: 1

H: 32.13    W: 30.88    D: 35.75    Wt: 150    Cu.Ft.: 20.5

DIMENSIONS - LID CLOSED

H: 48.1    W: 61.5    D: 27

DIMENSIONS - LID OPEN

H: 62.1    W: 61.5    D: 30.6



# SMART GRILLS

MSRP

## GENESIS EX-335 SMART GAS GRILL

35610001

\$1,899.00

GENESIS EX-335 SMART GAS GRILL BLACK LP

MASTER CARTON: 1

H: 32.13 W: 30.88 D: 35.75 Wt:178 Cu.Ft.: 20.5

DIMENSIONS - LID CLOSED

H: 48.1 W: 61.5 D: 27

DIMENSIONS - LID OPEN

H: 62.1 W: 61.5 D: 30.6



- Integrated **WEBER CONNECT** smart grilling technology:
  - Step-by-step grilling assistance
  - Real time food temperature monitoring
  - WiFi and Bluetooth connected for remote grill access
  - Fuel level indications on display or your phone (LP models only)
  - Integrated ambient thermometer to measure temp of the grill
- LCD display, 1 plug-in cord included and optional 5V USB-C input
- Includes one meat probe, two probe capacity
- Porcelain-enameled, cast-iron cooking grates
- **WEBER CRAFTED** Outdoor Kitchen Collection frame
- Stainless steel **FLAVORIZER** bars
- Primary cooking area = 513 square inches
- Expandable top cooking grate area = 274 square inches
- Total cooking area = 787 square inches
- Three main stainless steel burners plus an additional Sear Zone burner
- 39,000 BTU-per-hour input main burners
- 13,000 BTU-per-hour input Sear burner
- 12,000 BTU-per-hour input Side Burner
- Porcelain-enameled lid
- Painted steel cabinet and doors
- Metal T-bar handle
- Premium knobs provide a precise fit and finish
- Side storage cabinet, fits **WEBER CRAFTED** grillware
- Pull & clean grease management system
- Tank scale fuel gauge - LP models only (tank not included)
- Six tool hooks
- 4 Metal casters with rubber tread provide extra mobility (2 front locking casters/2 back casters)
- Natural gas grill includes a 10-foot flexible hose

37610001

\$1,949.00

GENESIS EX-335 SMART GAS GRILL BLACK NATURAL GAS

MASTER CARTON: 1

H: 32.13 W: 30.88 D: 35.75 Wt:178 Cu.Ft.: 20.5

DIMENSIONS - LID CLOSED

H: 48.1 W: 61.5 D: 27

DIMENSIONS - LID OPEN

H: 62.1 W: 61.5 D: 30.6



## GENESIS SX-335 SMART GAS GRILL

35600001

\$2,099.00

GENESIS SX-335 SMART GAS GRILL STAINLESS STEEL LP

MASTER CARTON: 1

H: 32.13 W: 30.88 D: 35.75 Wt:196 Cu.Ft.: 20.5

DIMENSIONS - LID CLOSED

H: 48.1 W: 61.5 D: 27

DIMENSIONS - LID OPEN

H: 62.1 W: 61.5 D: 30.6



- Integrated **WEBER CONNECT** smart grilling technology:
  - Step-by-step grilling assistance
  - Real time food temperature monitoring
  - WiFi and Bluetooth connected for remote grill access
  - Fuel level indications on display or your phone (LP models only)
  - Integrated ambient thermometer to measure temp of the grill
- LCD display, 1 plug-in cord included and optional 5V USB-C input
- Includes one meat probe, two probe capacity
- 7mm Stainless Steel grates
- **WEBER CRAFTED** Outdoor Kitchen Collection frame
- Stainless steel **FLAVORIZER** bars
- Primary cooking area = 513 square inches
- Expandable top cooking grate area = 274 square inches
- Total cooking area = 787 square inches
- Three main stainless steel burners plus an additional Sear Zone burner
- 39,000 BTU-per-hour input main burners
- 13,000 BTU-per-hour input Sear burner
- 12,000 BTU-per-hour input Side Burner
- Stainless steel lid & doors
- Metal T-bar handle
- Premium knobs provide a precise fit and finish
- Side storage cabinet, fits **WEBER CRAFTED** grillware
- Pull & clean grease management system
- Tank scale fuel gauge - LP models only (tank not included)
- Six tool hooks
- 4 Metal casters with rubber tread provide extra mobility (2 front locking casters/2 back casters)
- Natural gas grill includes a 10-foot flexible hose

37600001

\$2,149.00

GENESIS SX-335 SMART GAS GRILL STAINLESS STEEL NATURAL GAS

MASTER CARTON: 1

H: 32.13 W: 30.88 D: 35.75 Wt:178 Cu.Ft.: 20.5

DIMENSIONS - LID CLOSED

H: 48.1 W: 61.5 D: 27

DIMENSIONS - LID OPEN

H: 62.1 W: 61.5 D: 30.6



MSRP

## GENESIS EPX-335 GAS GRILL

**35810001**

\$2,149.00

GENESIS EPX-335 GAS GRILL

BLACK

LP

MASTER CARTON: 1

H: 32.13 W: 30.88 D: 35.75 Wt: 210 Cu.Ft.: 20.1

DIMENSIONS - LID CLOSED

H: 48.1 W: 61.5 D: 27

DIMENSIONS - LID OPEN

H: 62.1 W: 61.5 D: 30.6



- Integrated **WEBER CONNECT** smart grilling technology:
  - Step-by-step grilling assistance
  - Real time food temperature monitoring
  - WiFi connected for remote grill access
  - Low fuel indications on your phone
  - Integrated ambient thermometer to measure temp of the grill
- Digital LED display
- Includes one meat probe, two probe capacity
- Primary cooking area = 513 square inches
- Expandable cooking grate area = 274 square inches
- Total cooking area = 787 square inches
- Three stainless steel burners
- 39,000 BTU-per-hour input main burners
- 13,000 BTU-per-hour input Sear Zone burner
- 12,000 BTU-per-hour input side burner
- Porcelain-enameled, cast-iron cooking grates
- **WEBER CRAFTED** cooking grates & frame
- Stainless steel **FLAVORIZER** bars
- Flush electronic push button ignition system, 1 AA battery included
- Porcelain-enameled lid
- Control knob lighting
- Night time grill lighting, 3 C-cell batteries included
- Extra large prep & serve table
- Painted enclosed steel cabinet with painted steel door
- Grill locker
- Pull & clean grease management system
- One grease scraper included
- Visible front tanks scale
- Fuel gauge - LP models only (tank not included)
- Six tool hooks
- Two front locking castors / Two back swivel casters
- Propane tank inside the cabinet
- Natural gas grill includes a 10-foot flexible hose

**37810001**

\$2,199.00

GENESIS EPX-335 GAS GRILL

BLACK

NATURAL GAS

MASTER CARTON: 1

H: 31.5 W: 32.1 D: 30.9 Wt: 178 Cu.Ft.: 20.5

DIMENSIONS - LID CLOSED

H: 48.1 W: 61.5 D: 27

DIMENSIONS - LID OPEN

H: 62.1 W: 61.5 D: 30.6



## GENESIS SPX-435 SMART GAS GRILL

**36800001**

\$2,599.00

GENESIS SPX-435 SMART GAS GRILL STAINLESS STEEL LP

MASTER CARTON: 1

H: 32.38 W: 36.07 D: 38.19 Wt:188 Cu.Ft.: 25.8

DIMENSIONS - LID CLOSED

H: 48.1 W: 68.5 D: 27

DIMENSIONS - LID OPEN

H: 62.1 W: 68.5 D: 30.6



**38800001**

\$2,649.00

GENESIS SPX-435 SMART GAS GRILL STAINLESS STEEL NATURAL GAS

MASTER CARTON: 1

H: 32.38 W: 36.07 D: 38.19 Wt:188 Cu.Ft.: 25.8

DIMENSIONS - LID CLOSED

H: 48.1 W: 68.5 D: 27

DIMENSIONS - LID OPEN

H: 62.1 W: 68.5 D: 30.6



- Integrated **WEBER CONNECT** smart grilling technology:
  - Step-by-step grilling assistance
  - Real time food temperature monitoring
  - WiFi and Bluetooth connected for remote grill access
  - Fuel level indications on display or your phone (LP models only)
  - Integrated ambient thermometer to measure temp of the grill
- Backlit main control knobs
- Night time LED grill motion lighting (3 x C-type batteries)
- LCD display, 1 plug-in cord included and optional 5V USB-C input
- Includes one meat probe, two probe capacity
- 7mm Stainless Steel grates
- Stainless steel **FLAVORIZER** bars
- Primary cooking area = 646 square inches
- Expandable top cooking grate area = 348 square inches
- Total cooking area = 994 square inches
- Four main stainless steel burners plus an additional Sear Zone burner
- 48,000 BTU-per-hour input main burners
- 12,000 BTU-per-hour input Sear Zone
- 12,000 BTU-per-hour input side burner
- Stainless steel lid & doors
- Metal T-bar handle
- Premium knobs provide a precise fit and finish
- Side storage cabinet, fits **WEBER CRAFTED** grillware
- Pull & clean grease management system
- Tank scale fuel gauge - LP models only (tank not included)
- Six tool hooks
- 4 Metal casters with rubber tread provide extra mobility (2 front locking casters/2 back casters)
- Natural gas grill includes a 10-foot flexible hose



MAP

MSRP

## SMOKEY JOE CHARCOAL GRILL

**10020**

\$65.99

\$71.99

SMOKEY JOE CHARCOAL GRILL

14 INCH BLACK

MASTER CARTON: 4

H: 18.1 W: 15.4 D: 32.8 Wt: 37.7 Cu.Ft.: 5.3

DIMENSIONS

H: 17 W: 14.2 D: 14.5



- Cooking area = 147 square inches
- Plated steel cooking grate
- Porcelain-enameled bowl and lid
- Rust-resistant aluminum damper
- One glass-reinforced nylon handle
- Aluminum ash catcher

## SMOKEY JOE PREMIUM CHARCOAL GRILL

**40020**

\$72.99

\$83.99

SMOKEY JOE PREMIUM CHARCOAL GRILL

14 INCH BLACK

MASTER CARTON: 4

H: 18.1 W: 16.9 D: 16.2 Wt: 39.3 Cu.Ft.: 5.3

DIMENSIONS

H: 17 W: 14.2 D: 16.5



- Cooking area = 147 square inches
- Plated steel cooking grate
- Porcelain-enameled bowl and lid
- Rust-resistant aluminum damper
- One glass-reinforced nylon handle
- **TUCK-N-CARRY** lid lock doubles as a carry handle and lid holder

## JUMBO JOE CHARCOAL GRILL

**1211001**

\$109.99

\$120.99

JUMBO JOE CHARCOAL GRILL

18 INCH BLACK

MASTER CARTON: 1

H: 8.8 W: 19.5 D: 19.5 Wt: 18 Cu.Ft.: 2

DIMENSIONS

H: 19.7 W: 20.5 D: 19.7



- Cooking area = 240 square inches
- Plated steel cooking grate
- Porcelain-enameled bowl and lid
- Rust-resistant aluminum dampers
- Rust-resistant aluminum ash catcher
- Lid handle with heat shield
- **TUCK-N-CARRY** lid lock doubles as a carry handle and lid holder

## GO-ANYWHERE CHARCOAL GRILL

**121020**

\$99.99

\$108.99

GO-ANYWHERE CHARCOAL GRILL

BLACK

MASTER CARTON: 4

H: 14.5 W: 21 D: 12.2 Wt: 56.9 Cu.Ft.: 5.9

DIMENSIONS

H: 15 W: 19.5 D: 11.5



- Cooking area = 160 square inches
- Plated steel cooking grate
- Porcelain-enameled base and lid
- Rust-resistant aluminum dampers
- Three glass-reinforced nylon handles
- Plated steel legs pivot to lock lid in place for carrying

# CHARCOAL GRILLS

MAP

MSRP

## ORIGINAL KETTLE CHARCOAL GRILL

**441001**

\$159.00

\$164.00

ORIGINAL KETTLE CHARCOAL GRILL

18 INCH BLACK

MASTER CARTON: 1

H: 14.8 W: 20.5 D: 20.5 Wt: 21 Cu.Ft.: 3.5

DIMENSIONS

H: 36 W: 23 D: 18.5



- 18 inch cooking area = 240 square inches
- 22 inch cooking area = 363 square inches
- Plated steel cooking grate
- Porcelain-enameled bowl and lid
- Aluminized steel **ONE-TOUCH** cleaning system
- Rust-resistant ash catcher
- Rust-resistant aluminum damper
- Glass-reinforced nylon bowl handle
- Glass-reinforced nylon lid handle with heat shield
- Spring clip/push pin leg assembly
- Durable all-weather wheels
- Angled lid hook inside grill lid

**741043**

\$199.00

\$208.00

ORIGINAL KETTLE CHARCOAL GRILL

22 INCH BLACK

MASTER CARTON: 1

H: 15 W: 24.5 D: 24.5 Wt: 37 Cu.Ft.: 5.1

DIMENSIONS

H: 39.5 W: 25 D: 22.5



MSRP

17951	<b>WEBER BRIQUETTES</b>	\$22.99	
	<ul style="list-style-type: none"> <li>• 100% all natural hardwood charcoal</li> <li>• Burns long with consistent heat</li> <li>• Waterproof, resealable bag</li> <li>• 20 lb bag</li> </ul>	<p><b>MASTER PALLET: 35</b></p> <p>L: 48 W: 40 H: 32 Wt: 770 Cu.Ft.: 35.5</p>	
	<p><b>INDIVIDUAL CARTON:</b></p> <p>L: 12.25 W: 7.5 H: 29.5 Wt: 20</p>		

MAP

MSRP

## ORIGINAL KETTLE PREMIUM CHARCOAL GRILL

**14401001**

\$279.00

\$308.00

ORIGINAL KETTLE PREMIUM CHARCOAL GRILL 22 INCH BLACK

MASTER CARTON: 1

H: 15 W: 24.5 D: 24.5 Wt: 37 Cu.Ft.: 5.1

DIMENSIONS

H: 39.5 W: 27 D: 22.5



**14402001**

\$289.00

\$318.00

ORIGINAL KETTLE PREMIUM CHARCOAL GRILL 22 INCH COPPER

MASTER CARTON: 1

L: 24.4 W: 24.4 H: 14.9 Wt: 37.3 Cu.Ft.: 5.1

DIMENSIONS

H: 39.5 W: 27 D: 22.5



- Cooking area = 363 square inches
- Plated steel, hinged cooking grate
- Porcelain-enameled bowl and lid
- Aluminized steel **ONE-TOUCH** cleaning system
- Removable, high-capacity, aluminum ash catcher
- Rust-resistant aluminum damper
- Glass-reinforced nylon bowl handles with tool hooks
- Glass-reinforced nylon lid handle with heat shield
- Spring clip/push pin leg assembly
- Durable all-weather wheels
- Angled lid hook inside grill lid
- Built-in lid thermometer

**14407001**

\$289.00

\$318.00

ORIGINAL KETTLE PREMIUM CHARCOAL GRILL 22 INCH GREEN

MASTER CARTON: 1

L: 24.4 W: 24.4 H: 14.9 Wt: 37.3 Cu.Ft.: 5.1

DIMENSIONS

H: 39.5 W: 27 D: 22.5



**14403001**

\$289.00

\$318.00

ORIGINAL KETTLE PREMIUM CHARCOAL GRILL 22 INCH CRIMSON

MASTER CARTON: 1

H: 15 W: 24.5 D: 24.5 Wt: 37 Cu.Ft.: 5.1

DIMENSIONS

H: 39.5 W: 27 D: 22.5



# CHARCOAL GRILLS

MAP

MSRP

## ORIGINAL KETTLE PREMIUM CHARCOAL GRILL

16401001

\$579.00

\$626.00

ORIGINAL KETTLE PREMIUM CHARCOAL GRILL 26 INCH BLACK

MASTER CARTON: 1

H: 19 W: 30 D: 30 Wt: 63 Cu.Ft.: 9.9

DIMENSIONS

H: 42.3 W: 32 D: 24.4



- Cooking area = 508 square inches
- Stainless steel hinged cooking grate
- Porcelain-enameled bowl and lid
- Stainless steel **ONE-TOUCH** cleaning system
- Removable, high-capacity, aluminum ash catcher
- Rust-resistant aluminum damper
- Glass-reinforced nylon bowl handle with tool hooks
- Glass-reinforced nylon lid handle with heat shield
- Spring clip/push pin leg assembly
- Durable all-weather 8 inch rubber molded wheels
- Tuck-Away lid holder
- Two **CHAR-BASKET** charcoal fuel holders
- Built-in lid thermometer

## MASTER-TOUCH PREMIUM CHARCOAL GRILL

17301001

\$519.00

\$560.00

MASTER-TOUCH PREMIUM CHARCOAL GRILL 22 INCH BLACK

MASTER CARTON: 1

H: 16 W: 25.25 D: 25.25 Wt: 40 Cu.Ft.: 5.7

DIMENSIONS

H: 39 W: 26 D: 30



- Three-in-one design allows you to grill, roast, or smoke low-and-slow.
- The lid is hinged for added convenience while grilling.
- Cooking grate is compatible with Gourmet BBQ System inserts and hinged for easily adding charcoal.
- Primary cooking area = 363 square inches
- Warming rack area = 80 square inches
- Total cooking area = 443 square inches
- Porcelain-enameled bowl and lid
- Aluminized steel **ONE-TOUCH** cleaning system
- Removable, high-capacity, aluminum ash catcher
- Rust-resistant aluminum damper
- Glass-reinforced nylon bowl handle with tool hooks
- Glass-reinforced nylon lid handle with heat shield
- Spring clip/push pin leg assembly
- Durable all-weather 8 inch rubber molded wheels
- Tuck-Away lid holder
- Two **CHAR-BASKET** charcoal fuel holders
- Built-in lid thermometer

MAP

MSRP

## MASTER-TOUCH CHARCOAL GRILL

**14501001**

\$359.00

\$374.00

MASTER-TOUCH CHARCOAL GRILL

22 INCH BLACK

MASTER CARTON: 1

H: 15 W: 24.5 D: 24.5 Wt: 47 Cu.Ft.: 5.1

DIMENSIONS - LID CLOSED

H: 42 W: 24 D: 29.5



0 77924 03226 4

**14516001**

\$389.00

\$418.00

MASTER-TOUCH CHARCOAL GRILL

22 INCH DEEP OCEAN BLUE

MASTER CARTON: 1

H: 15 W: 24.5 D: 24.5 Wt: 47 Cu.Ft.: 5.1

DIMENSIONS - LID CLOSED

H: 42 W: 24 D: 29.5



0 77924 14863 7

**14505601**

\$389.00

\$418.00

MASTER-TOUCH CHARCOAL GRILL

22 INCH IVORY

MASTER CARTON: 1

H: 15 W: 24.5 D: 24.5 Wt: 47 Cu.Ft.: 5.1

DIMENSIONS - LID CLOSED

H: 42 W: 29.5 D: 24



0 77924 04184 6

**14510601**

\$389.00

\$418.00

MASTER-TOUCH CHARCOAL GRILL

22 INCH SMOKE

MASTER CARTON: 1

H: 15 W: 24.5 D: 24.5 Wt: 47 Cu.Ft.: 5.1

DIMENSIONS - LID CLOSED

H: 42 W: 29.5 D: 24



0 77924 04186 0

**14511601**

\$389.00

\$418.00

MASTER-TOUCH CHARCOAL GRILL

22 INCH SPRING GREEN

MASTER CARTON: 1

H: 15 W: 24.5 D: 24.5 Wt: 47 Cu.Ft.: 5.1

DIMENSIONS - LID CLOSED

H: 42 W: 29.5 D: 24



0 77924 04187 7

**14513601**

\$389.00

\$418.00

MASTER-TOUCH CHARCOAL GRILL

22 INCH SLATE

MASTER CARTON: 1

H: 15 W: 24.5 D: 24.5 Wt: 47 Cu.Ft.: 5.1

DIMENSIONS - LID CLOSED

H: 42 W: 29.5 D: 24



0 77924 04185 3



- Primary cooking area = 363 square inches
- Warming rack area = 80 square inches
- Total cooking area = 443 square inches
- **GOURMET BBQ SYSTEM** hinged cooking grate
- Porcelain-enameled bowl and lid
- Aluminized steel **ONE-TOUCH** cleaning system
- Removable, high-capacity, aluminum ash catcher
- Rust-resistant aluminum damper
- Glass-reinforced nylon bowl handle with tool hooks
- Glass-reinforced nylon lid handle with heat shield
- Spring clip/push pin leg assembly
- Durable all-weather 8 inch rubber molded wheels
- Tuck-Away lid holder
- Two **CHAR-BASKET** charcoal fuel holders
- Built-in lid thermometer

# CHARCOAL GRILLS

MAP

MSRP

## PERFORMER CHARCOAL GRILL

15301001

\$439.00

\$462.00

PERFORMER CHARCOAL GRILL

22 INCH BLACK

MASTER CARTON: 1

H: 17.5 W: 32.3 D: 27 Wt: 70 Cu.Ft.: 8.7

DIMENSIONS - LID CLOSED

H: 43.5 W: 42 D: 29



- Cooking area = 363 square inches
- **GOURMET BBQ SYSTEM** hinged cooking grate
- Porcelain-enameled bowl and lid
- Aluminized steel **ONE-TOUCH** cleaning system
- Removable, high-capacity, aluminum ash catcher
- Tuck-Away lid holder
- Rust-resistant aluminum damper
- Lid handle with heat shield
- Painted, metal fold-down table
- Heavy-duty steel cart frame
- Three tool hooks
- Built-in lid thermometer
- Wire bottom shelf
- Two durable all-weather wheels with full wheel hubs
- Two locking casters

## PERFORMER PREMIUM CHARCOAL GRILL

15401001

\$609.00

\$660.00

PERFORMER PREMIUM CHARCOAL GRILL

22 INCH BLACK

MASTER CARTON: 1

H: 20.3 W: 38.8 D: 27.3 Wt: 95 Cu.Ft.: 12.3

DIMENSIONS - LID CLOSED

H: 44.1 W: 48 D: 30



- Cooking area = 363 square inches
- **GOURMET BBQ SYSTEM** hinged cooking grate
- Porcelain-enameled bowl and lid
- Aluminized steel **ONE-TOUCH** cleaning system
- Removable, high-capacity, aluminum ash catcher
- Tuck-Away lid holder
- Rust-resistant aluminum damper
- Lid handle with heat shield
- Removable backlit LCD cook timer
- Two **CHAR-BASKET** charcoal fuel holders
- Painted, metal work table
- Heavy-duty steel cart frame
- Three tool hooks
- Built-in lid thermometer
- Weather-protected CharBin storage container
- Wire bottom shelf
- Two durable all-weather 8 inch rubber molded wheels
- Two locking casters

MAP

MSRP

## PERFORMER DELUXE CHARCOAL GRILL

**15501001**

\$689.00

\$736.00

PERFORMER DELUXE CHARCOAL GRILL

22 INCH BLACK

MASTER CARTON: 1

H: 20.3 W: 38.8 D: 27.3 Wt: 99 Cu.Ft.: 12.3

DIMENSIONS - LID CLOSED

H: 44.1 W: 48 D: 30



**15502001**

\$709.00

\$758.00

PERFORMER DELUXE CHARCOAL GRILL

22 INCH COPPER

MASTER CARTON: 1

H: 20.3 W: 38.8 D: 27.3 Wt: 99 Cu.Ft.: 12.3

DIMENSIONS - LID CLOSED

H: 44.1 W: 48 D: 30



- Cooking area = 363 square inches
- **GOURMET BBQ SYSTEM** hinged cooking grate
- Electronic **TOUCH-N-GO** gas ignition system
- Porcelain-enameled bowl and lid
- Aluminized steel **ONE-TOUCH** cleaning system
- Removable, high-capacity, aluminum ash catcher
- Tuck-Away lid holder
- Rust-resistant aluminum damper
- Lid handle with heat shield
- Removable backlit LCD cook timer
- Two **CHAR-BASKET** charcoal fuel holders
- Painted, metal work table
- Heavy-duty steel cart frame
- Three tool hooks
- Built-in lid thermometer
- Weather-protected CharBin storage container
- Wire bottom shelf
- Two durable all-weather 8 inch rubber molded wheels
- Two locking casters
- Uses disposable 14.1 or 16.4 oz. LP cylinders (sold separately)

**15507001**

\$709.00

\$758.00

PERFORMER DELUXE CHARCOAL GRILL

22 INCH GREEN

MASTER CARTON: 1

H: 20.3 W: 38.8 D: 27.3 Wt: 99 Cu.Ft.: 12.3

DIMENSIONS - LID CLOSED

H: 44.1 W: 48 D: 30



**15503001**

\$709.00

\$758.00

PERFORMER DELUXE CHARCOAL GRILL

22 INCH CRIMSON

MASTER CARTON: 1

H: 20.3 W: 38.8 D: 27.3 Wt: 99 Cu.Ft.: 12.3

DIMENSIONS - LID CLOSED

H: 43.5 W: 48 D: 30



# CHARCOAL GRILLS

MAP

MSRP

## SUMMIT KAMADO E6 CHARCOAL GRILL

18201001

\$1,649.00

\$1,980.00

SUMMIT KAMADO E6 CHARCOAL GRILL

24 INCH BLACK

MASTER CARTON: 1

H: 29.3 W: 36.8 D: 30.6 Wt: 142 Cu.Ft.: 18.7

DIMENSIONS - LID CLOSED

H: 44.9 W: 34.8 D: 35.8

DIMENSIONS - LID OPEN

H: 59.4 W: 34.8 D: 35.8



- Cooking area = 452 square inches
- **GOURMET BBQ SYSTEM** stainless steel hinged cooking grate
- Stainless steel diffuser plate
- Two position fuel grate
- Air-insulated double-walled porcelain-enameled lid and bowl
- **RAPIDFIRE** lid damper
- Lid thermometer
- Easy open lid hinge
- Stainless steel **ONE-TOUCH** cleaning system
- Removable, high-capacity, aluminum ash catcher
- Smoke/low and slow vent setting
- Two **CHAR-BASKET** charcoal fuel holders
- Two tool hooks
- Bottom wire rack & diffuser plate storage area
- Two swivel casters
- One locking caster

## SUMMIT KAMADO S6 CHARCOAL GRILL

18501101

\$2,639.00

\$2,860.00

SUMMIT KAMADO S6 CHARCOAL GRILL

24 INCH BLACK

MASTER CARTON: 1

H: 35 W: 57 D: 30.5 Wt: 238 Cu.Ft.: 32.4

DIMENSIONS - LID CLOSED

H: 47.7 W: 56.6 D: 35

DIMENSIONS - LID OPEN

H: 62.2 W: 56.6 D: 35



- Cooking area = 452 square inches
- **GOURMET BBQ SYSTEM** stainless steel hinged cooking grate
- Stainless steel diffuser plate
- Two position fuel grate
- Snap-Jet gas ignition system
- Air-insulated double-walled porcelain-enameled lid and bowl
- **RAPIDFIRE** lid damper
- Lid thermometer
- Easy open lid hinge
- Stainless steel **ONE-TOUCH** cleaning system
- Removable, high-capacity, aluminum ash catcher
- Smoke/low and slow vent setting
- Two **CHAR-BASKET** charcoal fuel holders
- Stainless steel tabletop
- Stainless steel wire basket
- Three stainless steel tool hooks
- Fuel Bag included
- Bottom wire rack
- Diffuser plate storage area
- Two durable all-weather 8 inch rubber molded wheels
- Two locking casters
- Uses disposable 14.1 or 16.4 oz. LP cylinders (sold separately)



MAP

MSRP

## SMOKEY MOUNTAIN COOKER SMOKER

**711001**

\$369.00

\$384.00

SMOKEY MOUNTAIN COOKER SMOKER

14 INCH BLACK

MASTER CARTON: 1

H: 23.5 W: 18 D: 17.8 Wt: 29 Cu.Ft.: 4.5

DIMENSIONS

H: 31.4 W: 14.7 D: 14.7



**721001**

\$539.00

\$594.00

SMOKEY MOUNTAIN COOKER SMOKER

18 INCH BLACK

MASTER CARTON: 1

H: 29.5 W: 21.8 D: 21.5 Wt: 51 Cu.Ft.: 8.2

DIMENSIONS

H: 41.7 W: 19.7 D: 19.7



- 14 inch cooking area = 286 square inches
- 18 inch cooking area = 481 square inches
- 22 inch cooking area = 726 square inches
- Two plated steel cooking grates
- Porcelain-enameled bowl, lid, center section, and water pan
- Charcoal chamber
- Built-in lid thermometer
- Silicone temperature grommet
- Four rust-resistant aluminum dampers
- Rust-resistant aluminum fuel door
- Glass-reinforced nylon handle(s)
- Rust-resistant aluminum heat shield
- Cover included

**731001**

\$659.00

\$714.00

SMOKEY MOUNTAIN COOKER SMOKER

22 INCH BLACK

MASTER CARTON: 1

H: 35 W: 27 D: 26.5 Wt: 78 Cu.Ft.: 13.8

DIMENSIONS

H: 48.5 W: 23 D: 24



## RANCH KETTLE

**60020**

\$2,199.00

\$2,299.00

RANCH KETTLE

37 INCH BLACK

MASTER CARTON: 1

H: 19 W: 42.3 D: 42 Wt: 152 Cu.Ft.: 19.9

DIMENSIONS

H: 42 W: 37.7 D: 44.7













- Cooking area = 1,104 square inches
- Stainless steel hinged cooking grate
- Porcelain-enameled bowl and lid
- Tuck-Away lid holder
- Rust-resistant aluminum dampers
- Removable ash catcher
- Heavy-duty steel cart
- Two glass-reinforced nylon handles
- Two locking casters
- Two durable all-weather wheels with full wheel hubs

# ACCESSORIES







MAP

MSRP

## COOKING: SMART ASSISTANTS

<p><b>3204</b> <b>WEBER CONNECT SMART GRILLING HUB</b></p>  <p><b>3 YEAR LIMITED WARRANTY</b></p>	<ul style="list-style-type: none"> <li>Compatible with any grill</li> <li>One meat probe, one ambient probe included</li> <li>Four probe capacity</li> <li>USB rechargeable battery</li> <li>WiFi and Bluetooth® enabled</li> <li>Free IOS &amp; Android app</li> <li>9 Segmented LED Display</li> <li>Embedded magnet</li> </ul>	<p style="text-align: right;">\$186.99</p> <p><b>MASTER CARTON: 4</b>  <b>H: 6.38 W: 6.00 D: 12.80 Wt: 4.32 Cu.Ft.: 0.28</b></p> <p><b>INDIVIDUAL CARTON:</b>  <b>H: 5.52 W: 5.52 D: 2.80 Wt: 1.08</b></p> <p><b>OUT OF CARTON:</b>  <b>H: 3.9 W: 2.9 D: 1.4</b></p>	 <p>0 77924 12962 9</p>
<p><b>3250</b> <b>WEBER CONNECT STORAGE AND TRAVEL CASE</b></p> 	<ul style="list-style-type: none"> <li>Stores <b>WEBER CONNECT</b> Hub and accessories</li> <li>Shockproof EVA foam interior provides secure fit and protection</li> <li>Durable exterior material is stain resistant and dust proof</li> </ul>	<p style="text-align: right;">\$43.99      \$47.99</p> <p><b>MASTER CARTON: 4</b>  <b>H: 10.25 W: 9.06 D: 12.20 Wt: 4.03 Cu.Ft.: 0.65</b></p> <p><b>INDIVIDUAL CARTON:</b>  <b>H: 8.90 W: 8.46 D: 2.95 Wt: 0.84</b></p> <p><b>OUT OF CARTON:</b>  <b>H: 8.8 W: 9 D: 2.8</b></p>	 <p>0 77924 15435 5</p>
<p><b>3254</b> <b>WEBER CONNECT 6-PIECE MOUNTING KIT</b></p> 	<ul style="list-style-type: none"> <li>Attachment kit for mounting <b>WEBER CONNECT</b> Hub to charcoal, smokers and gas grills</li> <li>Keep <b>WEBER CONNECT</b> Hub close-by while grilling</li> <li>Includes bag for convenient storage</li> </ul>	<p style="text-align: right;">\$43.99      \$47.99</p> <p><b>MASTER CARTON: 4</b>  <b>H: 6.30 W: 5.63 D: 8.27 Wt: 2.45 Cu.Ft.: 0.16</b></p> <p><b>INDIVIDUAL CARTON:</b>  <b>H: 5.58 W: 5.24 D: 1.97 Wt: 0.73</b></p> <p><b>OUT OF CARTON:</b>  <b>H: 6.75 W: 6.25 D: 1.5</b></p>	 <p>0 77924 15439 3</p>
<p><b>7211</b> <b>MEAT TEMPERATURE PROBE</b></p> 	<ul style="list-style-type: none"> <li>Monitors the internal temperature of your food as it grills</li> <li>One meat temperature probe included</li> <li>Four color-coded sleeves included</li> <li>Hand wash only</li> <li>Stainless steel</li> <li>Compatible with <b>iGRILL, WEBER CONNECT</b> and <b>WEBER SMART GRILLS</b></li> </ul>	<p style="text-align: right;">\$23.99</p> <p><b>MASTER CARTON: 5</b>  <b>H: 8.00 W: 5.38 D: 5.57 Wt: 1.35 Cu.Ft.: 0.14</b></p> <p><b>INDIVIDUAL CARTON:</b>  <b>H: 7.32 W: 4.57 D: 0.82 Wt: 0.18</b></p> <p><b>OUT OF CARTON:</b>  <b>H: 2.6 W: 0.5 D: 5</b></p>	 <p>0 77924 05217 0</p>
<p><b>7212</b> <b>AMBIENT TEMPERATURE PROBE</b></p> 	<ul style="list-style-type: none"> <li>Monitors the ambient temperature of the inside of your grill</li> <li>One ambient temperature probe included</li> <li>Four color-coded sleeves included</li> <li>Probe clip included</li> <li>Hand wash only</li> <li>Stainless steel</li> <li>Compatible with <b>iGRILL</b> and <b>WEBER CONNECT</b> devices</li> </ul>	<p style="text-align: right;">\$23.99</p> <p><b>MASTER CARTON: 5</b>  <b>H: 8.00 W: 5.38 D: 5.88 Wt: 1.35 Cu.Ft.: 0.14</b></p> <p><b>INDIVIDUAL CARTON:</b>  <b>H: 7.32 W: 4.57 D: 0.82 Wt: 0.18</b></p> <p><b>OUT OF CARTON:</b>  <b>H: 2.6 W: 0.5 D: 4.3</b></p>	 <p>0 77924 05218 7</p>

## COOKING: GRILLING TOOLS



6750	INSTANT READ THERMOMETER	\$19.99      \$21.99	
	<ul style="list-style-type: none"> <li>• Fast, accurate readings in Fahrenheit or Celsius</li> </ul>	<b>MASTER CARTON: 6</b> <b>H: 9.88    W: 3.46    D: 9.80    Wt: 1.20    Cu.Ft.: 0.19</b>	
	<b>INDIVIDUAL CARTON:</b> <b>H: 8.75    W: 2.94    D: 1.47    Wt: 0.14</b>		
	<b>OUT OF CARTON:</b> <b>H: 8        W: 1.3        D: 0.3</b>		
	7202	iGRILL MINI	\$89.99
	<ul style="list-style-type: none"> <li>• App-connected thermometer</li> <li>• Bluetooth® smart connection</li> <li>• Single probe capability (one Meat Probe included)</li> <li>• Smart LED</li> <li>• 150-hour battery life (battery included)</li> <li>• Hand wash only</li> </ul>	<b>MASTER CARTON: 5</b> <b>H: 8.23    W: 4.37    D: 13.51    Wt: 3.00    Cu.Ft.: 0.28</b>	
	<b>INDIVIDUAL CARTON:</b> <b>H: 7.40    W: 3.86    D: 2.56    Wt: 0.45</b>		
	<b>OUT OF CARTON:</b> <b>H: 2        W: 1.6        D: 1.5</b>		
	7203	iGRILL 2	\$149.99
	<ul style="list-style-type: none"> <li>• App-connected thermometer</li> <li>• Bluetooth® smart connection</li> <li>• Four probe capability (two Meat Probes included)</li> <li>• LED temperature read out</li> <li>• 200-hour battery life (batteries included)</li> <li>• Hand wash only</li> </ul>	<b>MASTER CARTON: 5</b> <b>H: 9.65    W: 7.75    D: 14.40    Wt: 6.00    Cu.Ft.: 0.62</b>	
	<b>INDIVIDUAL CARTON:</b> <b>H: 7.19    W: 8.86    D: 2.75    Wt: 1.00</b>		
	<b>OUT OF CARTON:</b> <b>H: 2.2     W: 3.2     D: 2.2</b>		
	6320	GRILLING SKEWER SET	\$15.99      \$17.99
	<ul style="list-style-type: none"> <li>• Set of 8 skewers</li> <li>• Dual-pronged design to prevent food from turning</li> <li>• Easily pierces food without damage</li> <li>• Hand wash only</li> </ul>	<b>MASTER CARTON: 6</b> <b>H: 13.88    W: 5.57    D: 4.32    Wt: 3.17    Cu.Ft.: 0.19</b>	
	<b>INDIVIDUAL CARTON:</b> <b>H: 13.1    W: 2.5     D: 1.3     Wt: 0.5</b>		
	<b>OUT OF CARTON:</b> <b>H: 13.00    W: 1.25    D: 1.0</b>		
	6317	GRILL TONGS	\$17.99      \$19.99
	<ul style="list-style-type: none"> <li>• Stainless steel construction</li> <li>• Locking mechanism for compact storage</li> <li>• Dishwasher safe for easy cleaning</li> <li>• Loop to hang tongs for easy storage</li> <li>• 1-year warranty</li> </ul>	<b>MASTER CARTON: 4</b> <b>H: 16.93    W: 5.12    D: 4.14    Wt: 2.85    Cu.Ft.: 0.21</b>	
	<b>INDIVIDUAL CARTON:</b> <b>H: 17.7     W: 1.6     D: 1.4     Wt: 0.6</b>		
	<b>OUT OF CARTON:</b> <b>H: 16.00    W: 1.73    D: 1.60</b>		
	6318	GRILL SPATULA	\$17.99      \$19.99
	<ul style="list-style-type: none"> <li>• Stainless steel construction</li> <li>• Dishwasher safe for easy cleaning</li> <li>• Loop to hang spatula for easy storage</li> <li>• 1-year warranty</li> </ul>	<b>MASTER CARTON: 4</b> <b>H: 16.93    W: 5.12    D: 4.14    Wt: 2.27    Cu.Ft.: 0.21</b>	
	<b>INDIVIDUAL CARTON:</b> <b>H: 15.8     W: 3.6     D: 1.2     Wt: 0.5</b>		
	<b>OUT OF CARTON:</b> <b>H: 16.00    W: 3.63    D: 2.00</b>		



# ACCESSORIES



MAP



MSRP



## COOKING: GRILLING TOOLS



<b>6319</b> GRILL BASTING BRUSH  <ul style="list-style-type: none"> <li>• Silicone bristles hold sauces and juices for basting</li> <li>• Dishwasher safe for easy cleaning</li> <li>• Loop to hang brush for easy storage</li> <li>• 1-year warranty</li> </ul>		\$15.99	\$17.99				
	<b>MASTER CARTON: 4</b>	H: 17.25	W: 5.04		D: 2.91	Wt: 1.53	Cu.Ft.: 0.15
	<b>INDIVIDUAL CARTON:</b>	H: 15.8	W: 1.2		D: 1.7	Wt: 0.3	
	<b>OUT OF CARTON:</b>	H: 18	W: 1.7		D: 1.0		

<b>6768</b> PRECISION GRILL TONGS  <ul style="list-style-type: none"> <li>• Flat, front edge design for precision control and better handling of food</li> <li>• Durable, stainless steel construction</li> <li>• Soft-touch handle for non-slip grip</li> <li>• Hands-free locking mechanism for ease of use and compact storage</li> <li>• Dishwasher safe for easy cleaning</li> <li>• Metal loop allows hanging storage</li> <li>• 2-year warranty</li> </ul>		\$32.99	\$35.99				
	<b>MASTER CARTON: 4</b>	H: 24.53	W: 5.04		D: 10.24	Wt: 5.55	Cu.Ft.: 0.73
	<b>INDIVIDUAL CARTON:</b>	H: 22.84	W: 4.26		D: 1.78	Wt: 0.94	
	<b>OUT OF CARTON:</b>	H: 18.00	W: 1.73		D: 2.00		







<b>6769</b> PRECISION GRILL SPATULA  <ul style="list-style-type: none"> <li>• 3-sided beveled edge design for easy approach and precision flip</li> <li>• Durable, stainless steel construction</li> <li>• Soft-touch handle designed for non-slip grip</li> <li>• Dishwasher safe for easy cleaning</li> <li>• Metal loop allows hanging storage</li> <li>• 2-year warranty</li> </ul>		\$25.99	\$30.99				
	<b>MASTER CARTON: 4</b>	H: 20.68	W: 6.19		D: 12.09	Wt: 5.71	Cu.Ft.: 0.90
	<b>INDIVIDUAL CARTON:</b>	H: 19.69	W: 5.82		D: 2.17	Wt: 0.96	
	<b>OUT OF CARTON:</b>	H: 18.00	W: 4.25		D: 2.13		

<b>6770</b> PRECISION WIDE GRILL SPATULA  <ul style="list-style-type: none"> <li>• 3-sided beveled edge design for easy approach and precision flip</li> <li>• Durable, stainless steel construction</li> <li>• Soft-touch handle designed for non-slip grip</li> <li>• Dishwasher safe for easy cleaning</li> <li>• Metal loop allows hanging storage</li> <li>• 2-year warranty</li> </ul>		\$35.99	\$41.99				
	<b>MASTER CARTON: 4</b>	H: 20.99	W: 8.04		D: 12.41	Wt: 6.99	Cu.Ft.: 1.21
	<b>INDIVIDUAL CARTON:</b>	H: 19.69	W: 7.29		D: 2.17	Wt: 1.04	
	<b>OUT OF CARTON:</b>	H: 18.00	W: 6.50		D: 2.30		



<b>6771</b> PRECISION GRILL TONGS & SPATULA SET  <ul style="list-style-type: none"> <li>• Includes Precision Grill Tongs and Spatula</li> <li>• Designed for precision control and better handling of food</li> <li>• 3-sided beveled edge design for easy approach and precision flip</li> <li>• Hands-free locking tongs for ease of use and compact storage</li> <li>• Durable, stainless steel construction</li> <li>• Soft-touch handle designed for non-slip grip</li> <li>• Dishwasher safe for easy cleaning</li> <li>• Metal loop allows hanging storage</li> <li>• 2-year warranty</li> </ul>		\$49.99	\$54.99				
	<b>MASTER CARTON: 4</b>	H: 24.53	W: 8.86		D: 12.21	Wt: 10.07	Cu.Ft.: 1.54
	<b>INDIVIDUAL CARTON:</b>	H: 22.84	W: 8.23		D: 2.17	Wt: 1.85	
	<b>OUT OF CARTON:</b>	<b>Spatula H: 18.00 W: 4.25 D: 2.13; Tongs - H: 18.00 W: 1.73 D: 2.00</b>					

<b>6772</b> PRECISION 3-PIECE GRILL TOOL SET  <ul style="list-style-type: none"> <li>• Includes Precision Grill Tongs, Spatula and Basting Brush</li> <li>• Designed for precision control and better handling of food</li> <li>• 3-sided beveled edge design for easy approach and precision flip</li> <li>• Hands-free locking tongs for ease of use and compact storage</li> <li>• Full-size silicone basting brush</li> <li>• Soft-touch handle designed for non-slip grip</li> <li>• Dishwasher safe for easy cleaning</li> <li>• Metal loop allows hanging storage</li> <li>• 2-year warranty</li> </ul>		\$60.99	\$65.99				
	<b>MASTER CARTON: 4</b>	H: 24.53	W: 11.42		D: 12.21	Wt: 11.85	Cu.Ft.: 1.98
	<b>INDIVIDUAL CARTON:</b>	H: 22.84	W: 10.64		D: 2.17	Wt: 2.28	
	<b>OUT OF CARTON:</b>	<b>Spatula H: 18.00 W: 4.25 D: 2.13; Tongs - H: 18.00 W: 1.73 D: 2.00; Brush - H: 18.00 W: 1.7 D: 1.00</b>					

## COOKING: GRILLING TOOLS

<b>6645</b>	<b>PREMIUM TOOL SET</b>		\$43.99	\$48.99	 0 77924 01119 1
 <ul style="list-style-type: none"> <li>• Compact size is perfect for camping, picnics, and urban dwellers</li> <li>• Set includes spatula and locking tongs</li> <li>• Stainless steel</li> <li>• 1-year warranty</li> </ul>			<b>MASTER CARTON: 4</b>		
			H: 12.25 W: 6.63 D: 18.19 Wt: 7.60 Cu.Ft.: 0.85		
			<b>INDIVIDUAL CARTON:</b>		
			H: 17.75 W: 5.90 D: 2.75 Wt: 1.89		
<b>OUT OF CARTON:</b>			<b>(Spatula) H: 14 W: 3.3 D: 1.2 (Tongs) H: 15 W: 3 D: 1.6</b>		
<b>6707</b>	<b>DELUXE TOOL SET</b>		\$58.99	\$64.99	 0 77924 02149 7
 <ul style="list-style-type: none"> <li>• Ergonomic design and soft-touch grip provide excellent control</li> <li>• Hands-free locking tongs</li> <li>• Set includes spatula and tongs</li> <li>• Stainless steel</li> <li>• 1-year warranty</li> </ul>			<b>MASTER CARTON: 4</b>		
			H: 21.50 W: 6.63 D: 11.19 Wt: 10.16 Cu.Ft.: 0.92		
			<b>INDIVIDUAL CARTON:</b>		
			H: 21.10 W: 6.10 D: 2.60 Wt: 2.54		
<b>OUT OF CARTON:</b>			<b>(Spatula) H: 18 W: 3.5 D: 4.5 (Tongs) H: 17 W: 1.2 D: 1.6</b>		
<b>6608</b>	<b>BAMBOO SKEWERS</b>		\$7.99	\$8.99	 0 77924 02194 7
 <ul style="list-style-type: none"> <li>• Disposable bamboo skewers</li> <li>• Set of 25</li> </ul>			<b>MASTER CARTON: 12</b>		
			H: 14.19 W: 4.07 D: 9.19 Wt: 2.83 Cu.Ft.: 0.30		
			<b>INDIVIDUAL CARTON:</b>		
			H: 13.50 W: 3.00 D: 0.63 Wt: 0.19		
<b>OUT OF CARTON:</b>			H: 9.8 W: 0.4 D: 0.1		

## COOKING: GRIDDLE TOOLS NEW













<b>6776</b>	<b>GRIDDLE ESSENTIAL SET</b>	<b>Available Feb 2023</b>	\$84.99	\$94.99	 0 77924 19353 8
 <ul style="list-style-type: none"> <li>• Griddle Spatula flips and moves heavier food with ease (1)</li> <li>• Griddle Scraper effectively removes grease and grime (1)</li> <li>• Flexible Griddle Spatula easily slides under delicate foods, like seafood and veggies (1)</li> <li>• Griddle Squeeze Bottles (2)</li> </ul>			<b>MASTER CARTON: 2</b>		
			H: 17.72 W: 12.6 D: 8.47 Wt: 7.17 Cu.Ft.: 1.09		
			<b>INDIVIDUAL CARTON:</b>		
			H: 17.13 W: 12.21 D: 3.86 Wt: 3.0		
<b>OUT OF CARTON: HxWxD</b>			<b>Spatula: 16.4 x 4.0 x 4.3 Scraper: 12.4 x 5.5 x 1.1 Flexible Spatula: 15.5 x 3.8 x 3.2 Bottle: 7.7 x 2.8 x 2.8</b>		
<b>6777</b>	<b>GRIDDLE STARTER SET</b>	<b>Available Feb 2023</b>	\$59.99	\$65.99	 0 77924 19354 5
 <ul style="list-style-type: none"> <li>• Griddle Spatula flips and moves heavier food with ease (1)</li> <li>• Griddle Scraper effectively removes grease and grime (1)</li> <li>• Griddle Squeeze Bottle (1)</li> <li>• Dishwasher safe and BPA Free</li> </ul>			<b>MASTER CARTON: 2</b>		
			H: 17.72 W: 9.45 D: 8.47 Wt: 5.52 Cu.Ft.: 0.82		
			<b>INDIVIDUAL CARTON:</b>		
			H: 17.13 W: 8.86 D: 3.86 Wt: 2.5		
<b>OUT OF CARTON: HxWxD</b>			<b>Spatula: 16.4 x 4.0 x 4.3 Scraper: 12.4 x 5.5 x 1.1 Bottle: 7.7 x 2.8 x 2.8</b>		

# ACCESSORIES



MAP



MSRP

## COOKING: GRIDDLE TOOLS NEW

6778	GRIDDLE BREAKFAST SET	Available Feb 2023	\$44.99	\$49.99	
		<ul style="list-style-type: none"> <li>• Egg Rings (2) are stackable and easy to store</li> <li>• Batter Dispenser (1) holds up to 27 oz. of batter, marinades and more</li> <li>• Dishwasher safe and BPA Free</li> </ul>	<b>MASTER CARTON: 2</b> <b>H: 12.01 W: 9.06 D: 4.73 Wt: 1.61 Cu.Ft.: 0.3</b> <b>INDIVIDUAL CARTON:</b> <b>H: 11.25 W: 4.38 D: 4.38 Wt: 0.6</b> <b>OUT OF CARTON: HxD</b> <b>Egg Rings: 1.2 x 4.1 Batter Dispenser: 10.5 x 2.8</b>		0 77924 19355 2
6779	GRIDDLE SPATULA	Available Jan 2023	\$32.99	\$35.99	
		<ul style="list-style-type: none"> <li>• Beveled edge easily slides under food from any direction.</li> <li>• No-slip handle is elevated to avoid resting on messy surfaces.</li> <li>• Dishwasher safe.</li> </ul>	<b>MASTER CARTON: 6</b> <b>H: 17.33 W: 4.73 D: 13 Wt: 6.95 Cu.Ft.: 0.62</b> <b>INDIVIDUAL CARTON:</b> <b>H: 16.54 W: 3.94 D: 1.97 Wt: 0.07</b> <b>OUT OF CARTON:</b> <b>H: 16.4 W: 4.0 D: 4.3</b>		0 77924 19356 9
6780	GRIDDLE FLEXIBLE SPATULA	Available Jan 2023	\$28.99	\$31.99	
		<ul style="list-style-type: none"> <li>• Beveled edge easily slides under delicate foods.</li> <li>• Slotted for no-stick release.</li> <li>• Angled to easily fold, flip and turn.</li> <li>• Dishwasher safe.</li> </ul>	<b>MASTER CARTON: 6</b> <b>H: 16.15 W: 4.33 D: 11.42 Wt: 3.31 Cu.Ft.: 0.46</b> <b>INDIVIDUAL CARTON:</b> <b>H: 15.36 W: 3.74 D: 1.78 Wt: 0.5</b> <b>OUT OF CARTON:</b> <b>H: 15.5 W: 3.8 D: 3.2</b>		0 77924 19357 6
6781	GRIDDLE SCRAPER	Available Jan 2023	\$28.99	\$31.99	
		<ul style="list-style-type: none"> <li>• Scrapes away grease and grime.</li> <li>• No-slip, easy grip handle.</li> <li>• Dishwasher safe.</li> </ul>	<b>MASTER CARTON: 6</b> <b>H: 13.39 W: 6.3 D: 10.24 Wt: 4.85 Cu.Ft.: 0.5</b> <b>INDIVIDUAL CARTON:</b> <b>H: 12.5 W: 5.71 D: 1.58 Wt: 0.9</b> <b>OUT OF CARTON:</b> <b>H: 12.4 W: 5.5 D: 1.1</b>		0 77924 19358 3
6782	GRIDDLE SQUEEZE BOTTLES	Available Feb 2023	\$19.99	\$21.99	
		<ul style="list-style-type: none"> <li>• 2 easy-to-dispense, 16 oz. bottles with twist-close cap to prevent spills.</li> <li>• Dishwasher safe and BPA free.</li> </ul>	<b>MASTER CARTON: 6</b> <b>H: 8.27 W: 6.74 D: 13.0 Wt: 1.82 Cu.Ft.: 0.42</b> <b>INDIVIDUAL CARTON:</b> <b>H: 12.25 W: 6.28 D: 2.62 Wt: 0.3</b> <b>OUT OF CARTON:</b> <b>H: 7.7 W: 2.8 D: 2.8</b>		0 77924 19359 0
6783	GRIDDLE BASTING DOME	Available Feb 2023	\$59.99	\$64.99	
		<ul style="list-style-type: none"> <li>• Melts cheese and steams veggies, rice and more</li> <li>• Covers up to 4 standard 4" burgers at once</li> <li>• T-shaped handle for ease of use</li> <li>• Dishwasher safe</li> </ul>	<b>MASTER CARTON: 4</b> <b>H: 11.62 W: 12.41 D: 18.9 Wt: 7.94 Cu.Ft.: 1.58</b> <b>INDIVIDUAL CARTON:</b> <b>H: 10.44 W: 10.44 D: 3.55 Wt: 1.13</b> <b>OUT OF CARTON:</b> <b>H: 10.2 W: 10.2 D: 4.9</b>		0 77924 19361 3

## COOKING: GRIDDLE TOOLS NEW

<b>6784</b>	GRIDDLE KEEP WARM RACK		\$47.99	\$52.99	 0 77924 19362 0		
	<ul style="list-style-type: none"> <li>• Highly durable construction</li> <li>• Raised back edge to lift food with ease</li> <li>• Collapsible legs for easy storage</li> </ul>	<b>MASTER CARTON: 4</b>					
		H: 8.67	W: 17.33	D: 9.45		Wt: 9.92	Cu.Ft.: 0.82
		<b>INDIVIDUAL CARTON:</b>					
H: 7.48	W: 15.75	D: 1.19	Wt: 1.5				
<b>OUT OF CARTON:</b>							
H: 2.6	W: 16.5	D: 7.8					

<b>6785</b>	GRIDDLE PRESS	<b>Available Dec 2022</b>	\$49.99	\$54.99	 0 77924 19363 7		
	<ul style="list-style-type: none"> <li>• Presses burgers and paninis, and up to 4 strips of bacon without curling.</li> <li>• Textured design keeps food from sticking.</li> </ul>	<b>MASTER CARTON: 4</b>					
		H: 4.33	W: 10.63	D: 18.7		Wt: 19.4	Cu.Ft.: 0.5
		<b>INDIVIDUAL CARTON:</b>					
H: 2.92	W: 8.86	D: 6.0	Wt: 3.75				
<b>OUT OF CARTON:</b>							
H: 2.9	W: 9.0	D: 6.0					

## WEBER CRAFTED: FRAME KITS

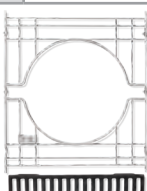
<b>7677</b>	WEBER CRAFTED FRAME KIT		\$84.99	 0 77924 17425 4			
	<ul style="list-style-type: none"> <li>• Frame Kit is required to use <b>WEBER CRAFTED</b> grillware</li> <li>• Sits under the right-side cooking grate when not in use</li> <li>• Fits <b>GENESIS</b> (2022), <b>GENESIS II</b> 300 and 400 series gas grills (2016+)</li> <li>• <b>GENESIS</b> 2016+ grills require new Weber Crafted grates (see page 38)</li> </ul>	<b>MASTER CARTON: 4</b>					
		H: 10	W: 19		D: 21.1	Wt: 31.9	Cu.Ft.: 2.3
		<b>INDIVIDUAL CARTON:</b>					
H: 2.1	W: 18.3	D: 20.2	Wt: 7.1				
<b>OUT OF CARTON:</b>							
H: 1.0	W: 61.50	D: 18.9					

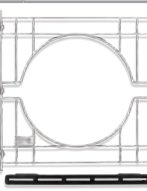









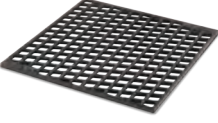

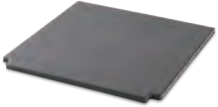
<b>7678</b>	WEBER CRAFTED FRAME KIT		\$84.99	 0 77924 17739 2			
	<ul style="list-style-type: none"> <li>• Frame Kit is required to use <b>WEBER CRAFTED</b> grillware</li> <li>• Sits under the right-side cooking grate when not in use</li> <li>• Fits <b>SPIRIT</b> 200 and 300 series, <b>SPIRIT II</b> 200 and 300 series, and <b>SMOKEFIRE</b> wood pellet grills</li> <li>• <b>SPIRIT</b> grills require new Weber Crafted grates (see page 38)</li> </ul>	<b>MASTER CARTON: 4</b>					
		H: 10	W: 19		D: 19.7	Wt: 25.4	Cu.Ft.: 2.2
		<b>INDIVIDUAL CARTON:</b>					
H: 2.1	W: 18.3	D: 18.9	Wt: 5.6				
<b>OUT OF CARTON:</b>							
H: 1.0	W: 61.50	D: 17.5					

# ACCESSORIES

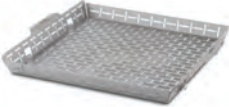
MAP











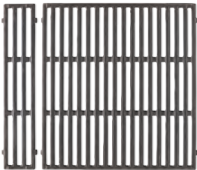

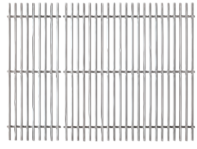
MSRP

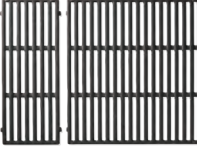
## WEBER CRAFTED: GRILLWARE (WEBER CRAFTED frame and grates required.)

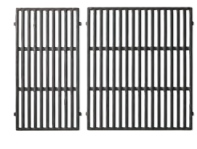
<p><b>7670</b> WEBER CRAFTED DUAL SIDED SEAR GRATE</p> 	<ul style="list-style-type: none"> <li>Creates restaurant-quality sear marks</li> <li>Designed to grill meat on one side, delicate food on the reverse</li> <li>Porcelain enamel helps make flipping and lifting food easy</li> <li>Extra large surface for searing multiple steaks at once</li> </ul>	<p>\$153.99      \$170.99</p> <p><b>MASTER CARTON: 1</b>  <b>H: 1.9    W: 18.7    D: 20.1    Wt: 11.4    Cu.Ft.: 0.4</b></p> <p><b>INDIVIDUAL CARTON:</b>  <b>H: 1.5    W: 18.3    D: 19.2    Wt: 10.3</b></p> <p><b>OUT OF CARTON:</b>  <b>H: 0.3    W: 16.0    D: 16.3</b></p>	 <p>0 77924 17439 1</p>
<p><b>7671</b> WEBER CRAFTED GLAZED BAKING STONE</p> 	<ul style="list-style-type: none"> <li>Designed to create perfectly crispy pizza crust</li> <li>Glazed finish helps keep food from sticking and cleanup easy</li> <li>Stone designed to efficiently absorb, retain, and distribute heat</li> <li>Fits <b>GENESIS</b> 300/400 series (2016+) &amp; <b>SPIRIT</b> 200/300 series with frame kit</li> </ul>	<p>\$153.99      \$170.99</p> <p><b>MASTER CARTON: 1</b>  <b>H: 3.7    W: 21.5    D: 20.9    Wt: 11.2    Cu.Ft.: 1.0</b></p> <p><b>INDIVIDUAL CARTON:</b>  <b>H: 3.0    W: 20.1    D: 19.9    Wt: 10.2</b></p> <p><b>OUT OF CARTON:</b>  <b>H: 0.5    W: 61.50    D: 16.3</b></p>	 <p>0 77924 17437 7</p>
<p><b>7672</b> WEBER CRAFTED FLAT TOP</p> 	<ul style="list-style-type: none"> <li>Make pancakes &amp; eggs to fajitas on the large, flat surface</li> <li>Heats quickly and evenly with warp-resistant carbon steel</li> <li>Rimmed edge helps keeps oil, and seasonings in place</li> <li>Fits <b>GENESIS</b> 300/400 series (2016+) &amp; <b>SPIRIT</b> 200/300 series with frame kit</li> </ul>	<p>\$190.99      \$211.99</p> <p><b>MASTER CARTON: 1</b>  <b>H: 2.8    W: 19.8    D: 20.3    Wt: 16.1    Cu.Ft.: 0.7</b></p> <p><b>INDIVIDUAL CARTON:</b>  <b>H: 2.3    W: 19.3    D: 19.8    Wt: 15.3</b></p> <p><b>OUT OF CARTON:</b>  <b>H: 1.0    W: 61.50    D: 16.3</b></p>	 <p>0 77924 17435 3</p>
<p><b>7673</b> WEBER CRAFTED ROASTING BASKET</p> 	<ul style="list-style-type: none"> <li>Roast small, delicate food without it falling through the grate</li> <li>WEBER CRAFTED frame and grates required</li> <li>Helps with heat circulation for perfectly roasted veggies</li> <li>Dishwasher safe, stainless-steel construction</li> <li>Fits <b>GENESIS</b> 300/400 series (2016+) &amp; <b>SPIRIT</b> 200/300 series with frame kit</li> </ul>	<p>\$153.99      \$170.99</p> <p><b>MASTER CARTON: 2</b>  <b>H: 2.7    W: 17.6    D: 17.6    Wt: 4.52    Cu.Ft.: 0.5</b></p> <p><b>INDIVIDUAL CARTON:</b>  <b>H: 2.0    W: 16.3    D: 17.2</b></p> <p><b>OUT OF CARTON:</b>  <b>H: 2.0    W: 61.5    D: 16.3</b></p>	 <p>0 77924 17433 9</p>
<p><b>7675</b> WEBER CRAFTED ROTISSERIE SKEWERS</p> 	<ul style="list-style-type: none"> <li>16-in. skewers slowly rotate for even cooking</li> <li>Simply slides onto the rotisserie spit</li> <li>Dishwasher safe, stainless-steel construction</li> <li>Grill rotisserie unit required for use</li> <li>Fits <b>GENESIS</b> 300/400 series (2016+) &amp; <b>SPIRIT</b> 200/300 series with frame kit</li> </ul>	<p>\$87.99      \$98.99</p> <p><b>MASTER CARTON: 2</b>  <b>H: 6.5    W: 6.1    D: 18.3    Wt: 5.2    Cu.Ft.: 0.4</b></p> <p><b>INDIVIDUAL CARTON:</b>  <b>H: 2.8    W: 6.0    D: 17.2    Wt: 2.3</b></p> <p><b>OUT OF CARTON:</b>  <b>H: 5.3    W: 61.50    D: 6.6</b></p>	 <p>0 77924 17429 2</p>
<p><b>7676</b> WEBER CRAFTED CRISPING BASKET</p>  <p><b>NEW</b></p>	<ul style="list-style-type: none"> <li>Circulates heat evenly for quick, crispy results.</li> <li>Quickly connects to your rotisserie spit.</li> <li>Crisp a variety of food all at once with the removable divider (included).</li> </ul>	<p>\$131.99      \$145.99</p> <p><b>MASTER CARTON: 1</b>  <b>H: 10.25    W: 18.3    D: 21.5    Wt: 10.6    Cu.Ft.: 2.3</b></p> <p><b>INDIVIDUAL CARTON:</b>  <b>H: 9.0    W: 9.85    D: 20.75    Wt: 5.2</b></p> <p><b>OUT OF CARTON:</b>  <b>H: 7.55    W: 19.11    D: 7.91</b></p>	 <p>0 77924 17427 8</p>

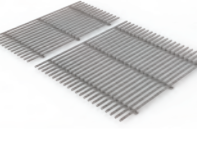

## WEBER CRAFTED: COOKING GRATES







<p><b>7849</b> <b>WEBER CRAFTED</b> PECI COOKING GRATES</p> 	<ul style="list-style-type: none"> <li>• Fits <b>SPIRIT</b> 200 series 2016+</li> <li>• Required to use most <b>WEBER CRAFTED</b> grillware</li> <li>• Superior heat retention and distribution</li> <li>• Set of 2</li> </ul>	<p>\$152.99      \$165.99</p> <p><b>MASTER CARTON: 1</b> H: 3.1    W: 19.9    D: 22.9    Wt: 13.5    Cu.Ft.: 0.8</p> <p><b>INDIVIDUAL CARTON:</b> H: 2.3    W: 19    D: 20.4    Wt: 10.9</p> <p><b>OUT OF CARTON:</b> H: 0.4    W: 20.3    D: 17.5</p>	 <p>0 77924 18070 5</p>
<p><b>7860</b> <b>WEBER CRAFTED</b> STAINLESS STEEL COOKING GRATES</p> 	<ul style="list-style-type: none"> <li>• Fits <b>SPIRIT</b> 300 series 2016+ and <b>SMOKEFIRE</b> EX4</li> <li>• Required to use most <b>WEBER CRAFTED</b> grillware</li> <li>• Highly durable 7mm stainless steel rods clean easily</li> <li>• Set of 2</li> </ul>	<p>\$196.99      \$216.99</p> <p><b>MASTER CARTON: 1</b> H: 3.6    W: 22.1    D: 23.5    Wt: 12.6    Cu.Ft.: 1.1</p> <p><b>INDIVIDUAL CARTON:</b> H: 2.3    W: 19.0    D: 21.9    Wt: 10.1</p> <p><b>OUT OF CARTON:</b> H: 0.6    W: 23.5    D: 17.3</p>	 <p>0 77924 18082 8</p>
<p><b>7856</b> <b>WEBER CRAFTED</b> PECI COOKING GRATES</p> 	<ul style="list-style-type: none"> <li>• Fits <b>SPIRIT</b> 300 series 2016+ and <b>SMOKEFIRE</b> EX4 grills</li> <li>• Required to use most <b>WEBER CRAFTED</b> grillware</li> <li>• Superior heat retention and distribution</li> <li>• Set of 2</li> </ul>	<p>\$170.99      \$184.99</p> <p><b>MASTER CARTON: 1</b> H: 3.1    W: 19.9    D: 22.9    Wt: 15.4    Cu.Ft.: 0.8</p> <p><b>INDIVIDUAL CARTON:</b> H: 2.3    W: 19.0    D: 20.4    Wt: 12.9</p> <p><b>OUT OF CARTON:</b> H: 0.4    W: 23.6    D: 17.5</p>	 <p>0 77924 18078 1</p>
<p><b>7853</b> <b>WEBER CRAFTED</b> PECI COOKING GRATE</p> 	<ul style="list-style-type: none"> <li>• Fits <b>GENESIS</b> 300 series grills 2016+</li> <li>• Required to use most <b>WEBER CRAFTED</b> grillware</li> <li>• Superior heat retention and distribution</li> <li>• Set of 2</li> </ul>	<p>\$214.99      \$234.99</p> <p><b>MASTER CARTON: 1</b> H: 3.1    W: 19.9    D: 23.7    Wt: 17.5    Cu.Ft.: 0.8</p> <p><b>INDIVIDUAL CARTON:</b> H: 2.3    W: 19.0    D: 21.9    Wt: 15.0</p> <p><b>OUT OF CARTON:</b> H: 0.4    W: 68.5    D: 18.9</p>	 <p>0 77924 18074 3</p>
<p><b>7852</b> <b>WEBER CRAFTED</b> STAINLESS STEEL COOKING GRATE</p> 	<ul style="list-style-type: none"> <li>• Fits <b>GENESIS</b> 300 series grills 2016+</li> <li>• Required to use most <b>WEBER CRAFTED</b> grillware</li> <li>• Highly durable 7mm stainless steel rods clean easily</li> <li>• Set of 2</li> </ul>	<p>\$290.99      \$323.99</p> <p><b>MASTER CARTON: 1</b> H: 3.1    W: 22.1    D: 23.5    Wt: 12.6    Cu.Ft.: 1.1</p> <p><b>INDIVIDUAL CARTON:</b> H: 2.3    W: 19.0    D: 21.9    Wt: 10.1</p> <p><b>OUT OF CARTON:</b> H: 0.6    W: 68.5    D: 18.9</p>	 <p>0 77924 18073 6</p>
<p><b>7854</b> <b>WEBER CRAFTED</b> PECI COOKING GRATES</p> 	<ul style="list-style-type: none"> <li>• Fits <b>GENESIS</b> 400 series grills 2016+</li> <li>• Required to use most <b>WEBER CRAFTED</b> grillware</li> <li>• Superior heat retention and distribution</li> <li>• Set of 3</li> </ul>	<p>\$258.99      \$284.99</p> <p><b>MASTER CARTON: 1</b> H: 4.1    W: 20.2    D: 25.9    Wt: 16.5    Cu.Ft.: 1.2</p> <p><b>INDIVIDUAL CARTON:</b> H: 3.3    W: 19.3    D: 23.5    Wt: 14.0</p> <p><b>OUT OF CARTON:</b> H: 0.4    W: 68.5    D: 18.9</p>	 <p>0 77924 18075 0</p>

# ACCESSORIES





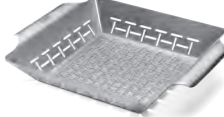

MAP

MSRP

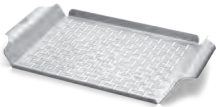









## COOKING: BASKETS AND PANS

8829	GRILLING STONE	 <ul style="list-style-type: none"> <li>Stone distributes heat quickly and evenly</li> <li>Specially formulated glaze promotes crispy, restaurant-quality crusts</li> <li>Durable finish resists fading, cracking and chipping</li> <li>Versatile stone is ideal for baking pizzas, cookies, breads and pastries</li> <li>Integrated handles make the stone easy to lift and move</li> <li>Safe for use with gas, charcoal and electric grills</li> </ul>	\$109.99	\$120.99	
			<b>MASTER CARTON: 1</b>		
			<b>H:</b> 5.04	<b>W:</b> 19.06	<b>D:</b> 20.63
			<b>Wt:</b> 10.00	<b>Cu.Ft.:</b> 1.14	
			<b>INDIVIDUAL CARTON:</b>		
			<b>H:</b> 19.06	<b>W:</b> 20.63	<b>D:</b> 5.04
			<b>Wt:</b> 10.00		
			<b>OUT OF CARTON:</b>		
			<b>H:</b> 18.5	<b>W:</b> 16.5	<b>D:</b> 1
6481	DELUXE GRILLING BASKET	 <ul style="list-style-type: none"> <li>Ideal for vegetables and smaller pieces of meat</li> <li>Stainless steel</li> <li>Fits all <b>WEBER</b> charcoal, gas, and electric grills</li> </ul>	\$31.99	\$45.99	
			<b>MASTER CARTON: 6</b>		
			<b>H:</b> 3.82	<b>W:</b> 8.75	<b>D:</b> 10.57
			<b>Wt:</b> 6.81	<b>Cu.Ft.:</b> 0.20	
			<b>INDIVIDUAL CARTON:</b>		
			<b>H:</b> 9.40	<b>W:</b> 7.5	<b>D:</b> 2.50
			<b>Wt:</b> 1.02		
			<b>OUT OF CARTON:</b>		
			<b>H:</b> 9.4	<b>W:</b> 7.5	<b>D:</b> 2.5
6434	DELUXE GRILLING BASKET	 <ul style="list-style-type: none"> <li>Ideal for vegetables and smaller pieces of meat</li> <li>Stainless steel</li> <li>Fits all <b>WEBER Q</b> 300/3000 and larger gas grills, and 18 inch and larger charcoal grills</li> </ul>	\$43.99	\$47.99	
			<b>MASTER CARTON: 4</b>		
			<b>H:</b> 3.12	<b>W:</b> 13.00	<b>D:</b> 15.25
			<b>Wt:</b> 9.15	<b>Cu.Ft.:</b> 0.35	
			<b>INDIVIDUAL CARTON:</b>		
			<b>H:</b> 13.80	<b>W:</b> 11.8	<b>D:</b> 2.50
			<b>Wt:</b> 2.02		
			<b>OUT OF CARTON:</b>		
			<b>H:</b> 13.8	<b>W:</b> 11.8	<b>D:</b> 2.5

## COOKING: RACKS AND ROASTERS

6435	DELUXE GRILLING PAN	 <ul style="list-style-type: none"> <li>Ideal for fish fillets or other delicate items that may fall between the grates</li> <li>Fits <b>WEBER Q</b> 300/3000 and larger gas grills, 22 inch and larger charcoal grills</li> </ul>	\$43.99	\$47.99	
			<b>MASTER CARTON: 6</b>		
			<b>H:</b> 2.88	<b>W:</b> 13.00	<b>D:</b> 18.63
			<b>Wt:</b> 14.20	<b>Cu.Ft.:</b> 0.40	
			<b>INDIVIDUAL CARTON:</b>		
			<b>H:</b> 17.57	<b>W:</b> 11.88	<b>D:</b> 1.38
			<b>Wt:</b> 2.14		
			<b>OUT OF CARTON:</b>		
			<b>H:</b> 17.4	<b>W:</b> 11.8	<b>D:</b> 1.4
6482	POULTRY ROASTER	 <ul style="list-style-type: none"> <li>Makes transporting your roasted chicken to and from the grill quick and easy</li> <li>Center ring holds 12 oz. beverage to infuse poultry with flavour</li> </ul>	\$32.99	\$35.99	
			<b>MASTER CARTON: 6</b>		
			<b>H:</b> 12.32	<b>W:</b> 7.57	<b>D:</b> 10.07
			<b>Wt:</b> 5.38	<b>Cu.Ft.:</b> 0.54	
			<b>INDIVIDUAL CARTON:</b>		
			<b>H:</b> 5.50	<b>W:</b> 9.3	<b>D:</b> 6.80
			<b>Wt:</b> 0.91		
			<b>OUT OF CARTON:</b>		
			<b>H:</b> 6.5	<b>W:</b> 9.3	<b>D:</b> 5
6731	DELUXE POULTRY ROASTER	 <ul style="list-style-type: none"> <li>Integrated cup holds juices, wine, beer and spices, infusing extra flavour into your poultry</li> <li>Easy to clean, non-stick coating</li> </ul>	\$76.99	\$82.99	
			<b>MASTER CARTON: 2</b>		
			<b>H:</b> 9.13	<b>W:</b> 9.25	<b>D:</b> 10.38
			<b>Wt:</b> 4.93	<b>Cu.Ft.:</b> 0.50	
			<b>INDIVIDUAL CARTON:</b>		
			<b>H:</b> 8.38	<b>W:</b> 9.88	<b>D:</b> 4.38
			<b>Wt:</b> 2.47		
			<b>OUT OF CARTON:</b>		
			<b>H:</b> 15.5	<b>W:</b> 12.3	<b>D:</b> 3.5

## COOKING: RACKS AND ROASTERS



6469	PREMIUM BARBECUE RACK	 <ul style="list-style-type: none"> <li>• 2-in-1 design for roasting large cuts of meat or grilling up to five racks of ribs</li> <li>• Fits <b>WEBER Q</b> 300/3000 and larger gas grills, and 22 inch and larger charcoal grills</li> </ul>	<p>\$40.99      \$45.99</p> <p><b>MASTER CARTON: 4</b></p> <p>H: 10.38    W: 11.32    D: 17.63    Wt: 8.31    Cu.Ft.: 1.20</p> <p><b>INDIVIDUAL CARTON:</b></p> <p>H: 16.80    W: 10.6    D: 4.40    Wt: 2.10</p> <p><b>OUT OF CARTON:</b></p> <p>H: 17.1    W: 10.5    D: 4.4</p>	 <p>0 77924 01083 5</p>
6605	RIB RACK	 <ul style="list-style-type: none"> <li>• Holds up to five racks of ribs, increasing grill capacity</li> <li>• Fits <b>WEBER Q</b> 200/2000 and larger gas grills, and 18 inch and larger charcoal grills</li> </ul>	<p>\$26.99      \$29.99</p> <p><b>MASTER CARTON: 6</b></p> <p>H: 11.2    W: 8.68    D: 13.81    Wt: 7.75    Cu.Ft.: 0.77</p> <p><b>INDIVIDUAL CARTON:</b></p> <p>H: 13.22    W: 8.16    D: 3.50    Wt: 1.13</p> <p><b>OUT OF CARTON:</b></p> <p>H: 13.2    W: 8    D: 3.5</p>	 <p>0 77924 02188 6</p>
7647	EXPANSION GRILLING RACK	 <ul style="list-style-type: none"> <li>• Adds grilling space for cooking larger meals</li> <li>• Stainless steel</li> <li>• Fits <b>SUMMIT</b> charcoal grills, 26 inch <b>WEBER</b> charcoal grills, 22 inch <b>SMOKEY MOUNTAIN COOKER</b> smoker, <b>GENESIS</b> and <b>SUMMIT</b> gas grills (with warming rack removed)</li> </ul>	<p>\$71.99      \$79.99</p> <p><b>MASTER CARTON: 2</b></p> <p>H: 4.94    W: 13.07    D: 20.25    Wt: 7.90    Cu.Ft.: 0.75</p> <p><b>INDIVIDUAL CARTON:</b></p> <p>H: 19.50    W: 12    D: 1.50    Wt: 3.20</p> <p><b>OUT OF CARTON:</b></p> <p>H: 22    W: 12.1    D: 5.1</p>	 <p>0 77924 04181 5</p>
6470	GRILLING BASKET	 <ul style="list-style-type: none"> <li>• Flexible wire accommodates a variety of food sizes and shapes</li> <li>• Stainless steel</li> <li>• Fits <b>WEBER Q</b> 100/1000 and larger gas grills, <b>SMOKEY JOE</b> and larger charcoal grills</li> </ul>	<p>\$51.99      \$56.99</p> <p><b>MASTER CARTON: 4</b></p> <p>H: 9.44    W: 11.32    D: 12.07    Wt: 5.30    Cu.Ft.: 0.74</p> <p><b>INDIVIDUAL CARTON:</b></p> <p>H: 8.19    W: 11.03    D: 2.07    Wt: 0.99</p> <p><b>OUT OF CARTON:</b></p> <p>H: 11    W: 8.1    D: 2.2</p>	 <p>0 77924 01113 9</p>
6471	GRILLING BASKET	 <ul style="list-style-type: none"> <li>• Flexible wire accommodates a variety of food sizes and shapes</li> <li>• Stainless steel</li> <li>• Fits <b>WEBER Q</b> 300/3000 and larger gas grills and 18 inch and larger charcoal grills</li> </ul>	<p>\$60.99      \$65.99</p> <p><b>MASTER CARTON: 4</b></p> <p>H: 12.50    W: 11.32    D: 19.07    Wt: 8.55    Cu.Ft.: 1.56</p> <p><b>INDIVIDUAL CARTON:</b></p> <p>H: 11.18    W: 18.11    D: 2.10    Wt: 1.70</p> <p><b>OUT OF CARTON:</b></p> <p>H: 18.1    W: 1.1    D: 2.2</p>	 <p>0 77924 01084 2</p>



# ACCESSORIES



MAP

MSRP









## COOKING: GOURMET BBQ SYSTEM

8835	COOKING GRATES		\$76.99	\$84.99	 0 77924 00490 2
 <ul style="list-style-type: none"> <li>• Hinged cooking grate for adding charcoal without removing the grate</li> <li>• For use with <b>GOURMET BBQ SYSTEM</b> inserts</li> <li>• Includes a 12 inch plated grate insert for traditional grilling</li> <li>• Fits 22 inch <b>WEBER</b> charcoal grills</li> </ul>			<b>MASTER CARTON: 5</b>		
			H: 3.38 W: 22.88 D: 22.88 Wt: 42.75 Cu.Ft.: 1.02		
			<b>INDIVIDUAL CARTON:</b>		
			H: 21.50 W: 21.50 D: 1.75 Wt: 8.22		
			<b>OUT OF CARTON:</b>		
			H: 21.5 W: 21.5 D: 1.5		

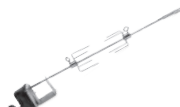
8859	DUTCH OVEN DUO		\$219.99	\$241.99	 0 77924 16218 3
 <ul style="list-style-type: none"> <li>• Multi-purpose cooker with a flat top lid that can be used as a griddle</li> <li>• Pieces can be used together or separately</li> <li>• Designed for compact storage</li> <li>• Easy to clean, porcelain-enameled, cast iron</li> <li>• Fits into the <b>GOURMET BBQ SYSTEM</b> cooking grate so that it stays in place while grilling</li> </ul>			<b>MASTER CARTON: 1</b>		
			H: 6.70 W: 16.93 D: 17.72 Wt: 24.24 Cu.Ft.: 1.16		
			<b>INDIVIDUAL CARTON:</b>		
			H: 16.14 W: 16.54 D: 5.71 Wt: 22.47		
			<b>OUT OF CARTON:</b>		
			H: 4.83 W: 16.68 D: 13.19		

8860	GRILL & GRIDDLE STATION		\$142.99	\$158.99	 0 77924 16219 0
 <ul style="list-style-type: none"> <li>• Grills and sears various foods at the same time, maximizing space</li> <li>• Easy to clean, porcelain-enameled, cast iron</li> <li>• Stacks for compact storage</li> <li>• Fits into the <b>GOURMET BBQ SYSTEM</b> cooking grate so that it stays in place while grilling</li> </ul>			<b>MASTER CARTON: 1</b>		
			H: 3.67 W: 11.03 D: 19.18 Wt: 14.60 Cu.Ft.: 0.44		
			<b>INDIVIDUAL CARTON:</b>		
			H: 10.25 W: 17.91 D: 3.15 Wt: 13.14		
			<b>OUT OF CARTON:</b>		
			H: 14.29 W: 14.10 D: 1.13		

## COOKING: ROTISSERIES







7659	ROTISSERIE	 <ul style="list-style-type: none"> <li>Forks designed to hold both large and small cuts of meat</li> <li>Includes stainless steel shaft, forks, handle, and hardware</li> <li>Fits <b>SPIRIT</b> and <b>SPIRIT II</b> 200/300 series gas grills</li> </ul>	<p>\$164.99      \$186.99</p> <p><b>MASTER CARTON: 1</b>  <b>H:</b> 4.50    <b>W:</b> 20.63    <b>D:</b> 5.94    <b>Wt:</b> 5.73    <b>Cu.Ft.:</b> 0.31</p> <p><b>INDIVIDUAL CARTON:</b>  <b>H:</b> 5.94    <b>W:</b> 20.63    <b>D:</b> 4.50    <b>Wt:</b> 5.73</p> <p><b>OUT OF CARTON:</b>  <b>H:</b> 33.4    <b>W:</b> 5.5    <b>D:</b> 5.2</p>	 <p>0 77924 05882 0</p>
7652	ROTISSERIE	 <ul style="list-style-type: none"> <li>Forks designed to hold both large and small cuts of meat</li> <li>Includes stainless steel shaft, forks, handle, and hardware</li> <li>Fits <b>GENESIS</b> (2022) &amp; <b>GENESIS II</b> 200 and 300 series gas grills</li> </ul>	<p>\$175.99      \$197.99</p> <p><b>MASTER CARTON: 1</b>  <b>H:</b> 3.44    <b>W:</b> 29.69    <b>D:</b> 5.50    <b>Wt:</b> 6.28    <b>Cu.Ft.:</b> 0.32</p> <p><b>INDIVIDUAL CARTON:</b>  <b>H:</b> 5.50    <b>W:</b> 29.69    <b>D:</b> 3.44    <b>Wt:</b> 6.28</p> <p><b>OUT OF CARTON:</b>  <b>H:</b> 42.1    <b>W:</b> 4.4    <b>D:</b> 5.6</p>	 <p>0 77924 05204 0</p>
7653	ROTISSERIE	 <ul style="list-style-type: none"> <li>Forks designed to hold both large and small cuts of meat</li> <li>Includes stainless steel shaft, forks, handle, and hardware</li> <li>Fits <b>GENESIS</b> (2022) &amp; <b>GENESIS II</b> 400 and 600 series gas grills</li> </ul>	<p>\$186.99      \$208.99</p> <p><b>MASTER CARTON: 1</b>  <b>H:</b> 3.44    <b>W:</b> 43.75    <b>D:</b> 5.50    <b>Wt:</b> 8.75    <b>Cu.Ft.:</b> 0.47</p> <p><b>INDIVIDUAL CARTON:</b>  <b>H:</b> 5.50    <b>W:</b> 43.75    <b>D:</b> 3.44    <b>Wt:</b> 8.75</p> <p><b>OUT OF CARTON:</b>  <b>H:</b> 55.7    <b>W:</b> 4.4    <b>D:</b> 5.6</p>	 <p>0 77924 05206 4</p>
2290	KETTLE ROTISSERIE	 <ul style="list-style-type: none"> <li>Porcelain-enameled ring elevates the rotisserie to optimize grilling space</li> <li>Includes a motor, 2 spit forks, and a shaft</li> <li>This item provided in non-retail, plain brown packaging</li> <li>Fits 22 inch <b>WEBER</b> charcoal grills</li> </ul>	<p>\$285.99      \$307.99</p> <p><b>MASTER CARTON: 1</b>  <b>H:</b> 7.44    <b>W:</b> 24.19    <b>D:</b> 30.75    <b>Wt:</b> 16.44    <b>Cu.Ft.:</b> 3.20</p> <p><b>INDIVIDUAL CARTON:</b>  <b>H:</b> 30.75    <b>W:</b> 24.19    <b>D:</b> 7.44    <b>Wt:</b> 16.44</p> <p><b>OUT OF CARTON:</b>  <b>H:</b> 36    <b>W:</b> 23.4    <b>D:</b> 6.3</p>	 <p>0 77924 02290 6</p>

# ACCESSORIES











MAP

MSRP

## COOKING: GRIDDLES

6787	SPIRIT FULL-SIZE GRIDDLE	Available Feb 2023	\$299.00	\$329.00	 0 77924 19374 3
NEW		<ul style="list-style-type: none"> <li>Converts <b>SPIRIT</b> 300 series gas grills* to a full-size griddle for best-of-both-worlds versatility *2016 and newer</li> <li>Compatible grease management prevents spills and effectively captures grease</li> <li>Durable carbon steel delivers even heat to easily sauté, brown or sear</li> </ul>	<b>MASTER CARTON: 1</b> H: 20.3 W: 26.0 D: 3.15 Wt: 22.0 Cu.Ft.: 0.96		
<b>INDIVIDUAL CARTON:</b> H: 20.3 W: 26.0 D: 3.15 Wt: 22.0					
<b>OUT OF CARTON:</b> H: 1.19 W: 22.67 D: 17.29					
6788		GENESIS FULL-SIZE GRIDDLE	Available Feb 2023	\$369.00	\$399.00
NEW		<ul style="list-style-type: none"> <li>Converts <b>GENESIS</b> 300 series gas grills* to a full-size griddle for best-of-both-worlds versatility *2016 and newer</li> <li>Compatible grease management prevents spills and effectively captures grease</li> <li>Durable carbon steel delivers even heat to easily sauté, brown or sear</li> </ul>	<b>MASTER CARTON: 1</b> H: 21.65 W: 29.0 D: 3.15 Wt: 26.3 Cu.Ft.: 1.14		
<b>INDIVIDUAL CARTON:</b> H: 21.65 W: 29.0 D: 3.15 Wt: 26.3					
<b>OUT OF CARTON:</b> H: 1.19 W: 25.67 D: 18.67					
6789		GENESIS FULL-SIZE GRIDDLE	Available Feb 2023	\$449.00	\$499.00
NEW		<ul style="list-style-type: none"> <li>Converts <b>GENESIS</b> 400 series gas grills* to a full-size griddle for best-of-both-worlds versatility *2016 and newer</li> <li>Compatible grease management prevents spills and effectively captures grease</li> <li>Durable carbon steel delivers even heat to easily sauté, brown or sear</li> </ul>	<b>MASTER CARTON: 1</b> H: 21.65 W: 36.0 D: 3.15 Wt: 33.2 Cu.Ft.: 1.42		
<b>INDIVIDUAL CARTON:</b> H: 21.65 W: 36.0 D: 3.15 Wt: 33.2					
<b>OUT OF CARTON:</b> H: 1.19 W: 32.67 D: 18.67					
7034		TRAVELER GRIDDLE		\$149.99	\$159.99
NEW		<ul style="list-style-type: none"> <li>Porcelain-enameled cast-iron material retains heat and requires no seasoning</li> <li>Surface prevents sticking</li> <li>Cleans easily with soap and water</li> <li>Fits <b>WEBER TRAVELER</b> grills</li> </ul>	<b>MASTER CARTON: 1</b> H: 17.95 W: 16.45 D: 1.15 Wt: 9.25 Cu.Ft.: 0.2		
<b>INDIVIDUAL CARTON:</b> H: 17.95 W: 16.45 D: 1.15 Wt: 9.25					
<b>OUT OF CARTON:</b> H: 0.5 W: 12.6 D: 13.5					
6611		LUMIN COMPACT GRIDDLE	Available Dec 2022	\$129.99	\$139.99
NEW		<ul style="list-style-type: none"> <li>Make a variety of foods—from eggs and pancakes to fish, vegetables and fruit</li> <li>Save time—porcelain enamel coating doesn't require seasoning and prevents food from sticking</li> <li>Designed to replace a grate in a <b>LUMIN</b> Compact electric grill</li> </ul>	<b>MASTER CARTON: 1</b> H: 12.5 W: 15.6 D: 1.25 Wt: 9.5 Cu.Ft.: 0.14		
<b>INDIVIDUAL CARTON:</b> H: 12.5 W: 15.6 D: 1.25 Wt: 9.5					
<b>OUT OF CARTON:</b> H: 0.5 W: 15.5 D: 11.5					
6612		LUMIN GRIDDLE	Available Dec 2022	\$139.99	\$149.99
NEW		<ul style="list-style-type: none"> <li>Make a variety of foods—from eggs and pancakes to fish, vegetables and fruit</li> <li>Save time—porcelain enamel coating doesn't require seasoning and prevents food from sticking</li> <li>Designed to replace a grate in a <b>LUMIN</b> electric grill</li> </ul>	<b>MASTER CARTON: 1</b> H: 13.7 W: 17.5 D: 1.25 Wt: 12.1 Cu.Ft.: 0.17		
<b>INDIVIDUAL CARTON:</b> H: 13.7 W: 17.95 D: 1.25 Wt: 12.1					
<b>OUT OF CARTON:</b> H: 0.5 W: 18.25 D: 13.0					

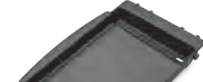
## COOKING: GRIDDLES



6558	WEBER Q GRIDDLE		\$76.99	\$84.99	 0 77924 02164 0
 <ul style="list-style-type: none"> <li>• Porcelain-enameled, cast-iron griddle provides exceptional heat retention and distribution ensuring evenly cooked food</li> <li>• Designed to replace a cooking grate</li> <li>• Fits <b>WEBER Q</b> 100/1000 series gas grills</li> </ul>			<b>MASTER CARTON: 1</b> H: 0.94 W: 15.94 D: 12.00 Wt: 5.79 Cu.Ft.: 0.10		
			<b>INDIVIDUAL CARTON:</b> H: 10.00 W: 15.94 D: 10.94 Wt: 5.79		
			<b>OUT OF CARTON:</b> H: 12.6 W: 8.6 D: 0.5		
6559	WEBER Q GRIDDLE		\$91.99	\$99.99	 0 77924 02163 3
 <ul style="list-style-type: none"> <li>• Porcelain-enameled, cast-iron griddle provides exceptional heat retention and distribution ensuring evenly cooked food</li> <li>• Designed to replace a cooking grate</li> <li>• Fits <b>WEBER Q</b> 200/2000 series gas grills</li> </ul>			<b>MASTER CARTON: 1</b> H: 0.82 W: 18.57 D: 14.713 Wt: 8.43 Cu.Ft.: 0.12		
			<b>INDIVIDUAL CARTON:</b> H: 14.13 W: 18.57 D: 0.82 Wt: 8.43		
			<b>OUT OF CARTON:</b> H: 15.3 W: 10.8 D: 0.5		
6506	WEBER Q GRIDDLE		\$98.99	\$109.99	 0 77924 07506 3
 <ul style="list-style-type: none"> <li>• Porcelain-enameled, cast-iron griddle provides exceptional heat retention and distribution ensuring evenly cooked food</li> <li>• Designed to replace a cooking grate</li> <li>• Fits <b>WEBER Q</b> 300/3000 series gas grills</li> </ul>			<b>MASTER CARTON: 1</b> H: 2.04 W: 18.67 D: 13.90 Wt: 12.00 Cu.Ft.: 0.30		
			<b>INDIVIDUAL CARTON:</b> H: 13.90 W: 18.67 D: 2.04 Wt: 12.00		
			<b>OUT OF CARTON:</b> H: 17.7 W: 12.9 D: 1.1		
7598	PORCELAIN-ENAMELED CAST IRON GRIDDLE		\$153.99	\$169.99	 0 77924 01914 2
 <ul style="list-style-type: none"> <li>• 2-sided, porcelain-enameled, cast-iron griddle</li> <li>• Textured side is ideal for paninis</li> <li>• Flat surface for delicate items such as scallops and shrimp</li> <li>• Fits <b>SMOKEFIRE</b> EX4 and EX6 Wood Pellet Grills, and <b>SPIRIT</b> 300 series gas grills</li> </ul>			<b>MASTER CARTON: 1</b> H: 1.32 W: 21.07 D: 14.32 Wt: 16.08 Cu.Ft.: 0.23		
			<b>INDIVIDUAL CARTON:</b> H: 14.32 W: 21.07 D: 1.32 Wt: 16.08		
			<b>OUT OF CARTON:</b> H: 0.50 W: 12.10 D: 17.40		
7658	GRIDDLE		\$142.99	\$158.99	 0 77924 05879 0
 <ul style="list-style-type: none"> <li>• Porcelain-enameled, cast-iron griddle provides exceptional heat retention and distribution ensuring evenly cooked food</li> <li>• Easy to clean semi-gloss enameled surface</li> <li>• Sloped cooking surface helps drain drippings away from food</li> <li>• Fits <b>SPIRIT</b> and <b>SPIRIT II</b> 200/300 series gas grills</li> </ul>			<b>MASTER CARTON: 1</b> H: 2.73 W: 19.63 D: 14.97 Wt: 15.00 Cu.Ft.: 0.46		
			<b>INDIVIDUAL CARTON:</b> H: 14.97 W: 19.63 D: 2.73 Wt: 15.00		
			<b>OUT OF CARTON:</b> H: 11.6 W: 16.8 D: 2		
7599	GRIDDLE		\$126.99	\$137.99	 0 77924 05197 5
 <ul style="list-style-type: none"> <li>• Porcelain-enameled, cast-iron griddle provides exceptional heat retention and distribution ensuring evenly cooked food</li> <li>• Easy to clean semi-gloss enameled surface</li> <li>• Sloped cooking surface helps drain drippings away from food</li> <li>• Fits <b>GENESIS II</b> 300, 400, and 600 series gas grills</li> </ul>			<b>MASTER CARTON: 1</b> H: 2.82 W: 21.63 D: 16.07 Wt: 17.50 Cu.Ft.: 0.56		
			<b>INDIVIDUAL CARTON:</b> H: 16.07 W: 21.63 D: 2.82 Wt: 17.50		
			<b>OUT OF CARTON:</b> H: 18.9 W: 13.2 D: 1.5		

# ACCESSORIES



MAP



MSRP



## COOKING: GRIDDLES



<b>7404</b>	<b>GRIDDLE</b>		\$126.99	\$137.99	 0 77924 08349 5		
 <ul style="list-style-type: none"> <li>• 2-sided, porcelain-enameled, cast-iron griddle</li> <li>• Textured side is ideal for paninis</li> <li>• Flat surface for delicate items such as scallops and shrimp</li> <li>• Fits <b>SUMMIT</b> 400/600 series (2007 and newer), <b>SUMMIT</b> Silver C/D, <b>SUMMIT</b> Gold A/B/D, <b>SUMMIT</b> Gold A6/B6/C4/D4/D6, and <b>SUMMIT</b> Platinum A6/B6</li> </ul>	<b>MASTER CARTON: 1</b>	<b>H:</b> 1.57	<b>W:</b> 23.25	<b>D:</b> 15.07		<b>Wt:</b> 17.44	<b>Cu.Ft.:</b> 0.31
	<b>INDIVIDUAL CARTON:</b>	<b>H:</b> 15.07	<b>W:</b> 23.25	<b>D:</b> 1.57		<b>Wt:</b> 17.44	
	<b>OUT OF CARTON:</b>	<b>H:</b> 19.2	<b>W:</b> 11.3	<b>D:</b> 0.9			



## COOKING: FUEL ACCESSORIES

<b>7666</b>	<b>CHARCOAL HEAT CONTROLLER</b>	<b>Available Feb 2023</b>	\$149.99	\$159.99	 0 77924 19194 7		
 <ul style="list-style-type: none"> <li>• Up to 7 hours of low-and-slow temp (225°F-275°F) before refueling</li> <li>• Diffuser ring maximizes entire 22" grate for indirect low-and-slow</li> <li>• Extreme direct high heat for searing; convection heat for crispy wings</li> </ul>	<b>MASTER CARTON: 3</b>	<b>H:</b> 13.5	<b>W:</b> 13.07	<b>D:</b> 20.69		<b>Wt:</b> 21.71	<b>Cu.Ft.:</b> 2.11
	<b>INDIVIDUAL CARTON:</b>	<b>H:</b> 12.25	<b>W:</b> 12.25	<b>D:</b> 6.63		<b>Wt:</b> 6.3	
	<b>OUT OF CARTON:</b>	<b>H:</b> 4.5	<b>W:</b> 18.3	<b>D:</b> 18.3			

<b>7007</b>	<b>FUEL STORAGE BAG</b>		\$43.99	\$48.99	 0 77924 15309 9		
 <ul style="list-style-type: none"> <li>• Weather resistant material designed to keep fuel dry &amp; BBQ ready</li> <li>• Holds up to 20 lbs of wood pellets or charcoal</li> <li>• Designed with a window for labeling different fuel</li> <li>• Bag folds flat when not in use</li> <li>• Unique bottom handle allows best grip for easy pouring</li> </ul>	<b>MASTER CARTON: 4</b>	<b>H:</b> 10.44	<b>W:</b> 6.70	<b>D:</b> 11.62		<b>Wt:</b> 4.84	<b>Cu.Ft.:</b> 0.47
	<b>INDIVIDUAL CARTON:</b>	<b>H:</b> 9.62	<b>W:</b> 6.02	<b>D:</b> 2.32		<b>Wt:</b> 1.04	
	<b>OUT OF CARTON:</b>	<b>H:</b> 18.8	<b>W:</b> 11.8	<b>D:</b> 11.8			







<b>17951</b>	<b>WEBER BRIQUETTES</b>			\$22.99	 0 77924 05258 3		
 <ul style="list-style-type: none"> <li>• 100% all natural hardwood charcoal</li> <li>• Burns long with consistent heat</li> <li>• Waterproof, resealable bag</li> <li>• 20 lb bag</li> </ul>	<b>MASTER PALLET: 35</b>	<b>L:</b> 48	<b>W:</b> 40	<b>H:</b> 32		<b>Wt:</b> 770	<b>Cu.Ft.:</b> 35.5
	<b>INDIVIDUAL CARTON:</b>	<b>L:</b> 12.25	<b>W:</b> 7.5	<b>H:</b> 29.5		<b>Wt:</b> 20	
	<b>OUT OF CARTON:</b>						

<b>7423</b>	<b>LIGHTER CUBES</b>		\$9.99	\$10.99	 0 77924 05736 6		
 <ul style="list-style-type: none"> <li>• Light easily even when wet</li> <li>• Use for lighting charcoal grills, smokers, fireplaces, or campfires</li> <li>• Box of 24 cubes</li> </ul>	<b>MASTER CARTON: 12</b>	<b>H:</b> 8.25	<b>W:</b> 9	<b>D:</b> 13.25		<b>Wt:</b> 10.45	<b>Cu.Ft.:</b> 0.56
	<b>INDIVIDUAL CARTON:</b>	<b>H:</b> 8.50	<b>W:</b> 6.25	<b>D:</b> 1.25		<b>Wt:</b> 0.87	
	<b>OUT OF CARTON:</b>	<b>H:</b> 1.1	<b>W:</b> 1.1	<b>D:</b> 0.8			



<b>7416</b>	<b>RAPIDFIRE CHIMNEY STARTER</b>		\$32.99	\$35.99	 0 77924 07393 9		
 <ul style="list-style-type: none"> <li>• Convenient and quick way to light charcoal</li> <li>• Two handle design provides more control when pouring lit charcoal</li> <li>• Works best with <b>WEBER</b> Lighter Cubes and Lighter Packs</li> </ul>	<b>MASTER CARTON: 4</b>	<b>H:</b> 12.76	<b>W:</b> 15.75	<b>D:</b> 21.54		<b>Wt:</b> 14.68	<b>Cu.Ft.:</b> 2.50
	<b>INDIVIDUAL CARTON:</b>	<b>H:</b> 12.00	<b>W:</b> 7.5	<b>D:</b> 12.75		<b>Wt:</b> 3.45	
	<b>OUT OF CARTON:</b>	<b>H:</b> 12.7	<b>W:</b> 8.1	<b>D:</b> 12.5			



## COOKING: FUEL ACCESSORIES

7447	<b>RAPIDFIRE COMPACT CHIMNEY STARTER</b>	\$26.99 \$28.99	 0 77924 01949 4
 <ul style="list-style-type: none"> <li>• Convenient and quick way to light charcoal</li> <li>• Compact design makes it ideal for smaller grills or shorter grilling sessions</li> <li>• Works best with <b>WEBER</b> Lighter Cubes and Lighter Packs</li> </ul>	<b>MASTER CARTON: 4</b>	H: 8.69 W: 12.44 D: 17.38 Wt: 10.88 Cu.Ft.: 1.08	
	<b>INDIVIDUAL CARTON:</b>	H: 8.00 W: 5.75 D: 10.25 Wt: 2.50	
	<b>OUT OF CARTON:</b>	H: 10.4 W: 5.8 D: 8	
7649	<b>CHARCOAL RAKE</b>	\$29.99 \$31.99	 0 77924 04183 9
 <ul style="list-style-type: none"> <li>• Designed to safely and conveniently arrange lit charcoal</li> <li>• Stainless steel</li> </ul>	<b>MASTER CARTON: 4</b>	H: 4.69 W: 21.82 D: 9.50 Wt: 3.94 Cu.Ft.: 0.56	
	<b>INDIVIDUAL CARTON:</b>	H: 4.00 W: 21.00 D: 1.88 Wt: 0.67	
	<b>OUT OF CARTON:</b>	H: 2.1 W: 3.9 D: 1.9	
7403	<b>CHAR-BASKETS</b>	\$29.99 \$31.99	 0 77924 07383 0
 <ul style="list-style-type: none"> <li>• Fill the <b>CHAR-BASKETS</b> with coal to easily and evenly set up for direct or indirect grilling</li> <li>• Set of two baskets</li> <li>• Fits 18 inch <b>WEBER</b> charcoal grills, 22 inch <b>WEBER</b> charcoal grills, and 26 inch <b>WEBER</b> charcoal grills</li> </ul>	<b>MASTER CARTON: 4</b>	H: 17.44 W: 11.07 D: 11.57 Wt: 9.28 Cu.Ft.: 1.29	
	<b>INDIVIDUAL CARTON:</b>	H: 16.82 W: 5.38 D: 5.07 Wt: 2.20	
	<b>OUT OF CARTON:</b>	H: 14.2 W: 3.6 D: 3.1	

## COOKING: ELECTRIC ACCESSORIES

6613	<b>VERSATILITY EXPANSION KIT – LUMIN COMPACT ELECTRIC GRILL</b>	\$99.99 \$109.99	 0 77924 19651 5 Available Dec 2022
 <p><b>NEW</b></p> <ul style="list-style-type: none"> <li>• Electric smoker conversion for low-and-slow-cooked favorites like ribs and pork shoulder</li> <li>• Two warming dishes to keep food warm and ready for buffet-style serving</li> <li>• Steam expansion enables use of entire grilling surface to steam seafood and veggies</li> <li>• Includes: Steaming/Smoking Reservoir, Reversible Steam Pan and Warming Dishes (2)</li> </ul>	<b>MASTER CARTON: 1</b>	H: 11.0 W: 12.4 D: 3.55 Wt: 4.3 Cu.Ft.: 0.28	
	<b>INDIVIDUAL CARTON:</b>	H: 11.0 W: 12.4 D: 3.55 Wt: 4.3	
	<b>OUT OF CARTON:</b>	H: 2.58 W: 8.48 D: 11.12	
	6614	<b>VERSATILITY EXPANSION KIT – LUMIN ELECTRIC GRILL</b>	\$114.99 \$129.99
 <p><b>NEW</b></p> <ul style="list-style-type: none"> <li>• Electric smoker conversion for low-and-slow-cooked favorites like ribs and pork shoulder</li> <li>• Two warming dishes to keep food warm and ready for buffet-style serving</li> <li>• Steam expansion enables use of entire grilling surface to steam seafood and veggies</li> <li>• Includes: Steaming/Smoking Reservoir, Reversible Steam Pan and Warming Dishes (2)</li> </ul>	<b>MASTER CARTON: 1</b>	H: 12.2 W: 14.4 D: 3.55 Wt: 5.5 Cu.Ft.: 0.36	
	<b>INDIVIDUAL CARTON:</b>	H: 12.2 W: 14.4 D: 3.55 Wt: 5.5	
	<b>OUT OF CARTON:</b>	H: 3.79 W: 9.72 D: 13.05	

# ACCESSORIES



MAP

MSRP



## COOKING: PELLET ACCESSORIES

190201	SMOKEFIRE PELLETS - GRILLMASTER BLEND	\$30.99	\$34.99	
	<ul style="list-style-type: none"> <li>• 20 lb bag</li> <li>• Premium Hardwood Pellets</li> <li>• Moderate flavour: balance and savory with a mild sweet finish</li> </ul>	50 BAGS PER PALLET		
		H: 28 W: 40 D: 48 Wt: 1,075.00 Cu.Ft.: 33.30		
		INDIVIDUAL CARTON:		
		H: 22.50 W: 16.5 D: 3.00 Wt: 20.00 lbs		
OUT OF CARTON:		H: 22.50 W: 16.5 D: 3.00		
190202	SMOKEFIRE PELLETS - HICKORY	\$30.99	\$34.99	
	<ul style="list-style-type: none"> <li>• 20 lb bag</li> <li>• Premium Hardwood Pellets</li> <li>• Moderate flavour: bold, bacon-like flavour</li> </ul>	50 BAGS PER PALLET		
		H: 28 W: 40 D: 48 Wt: 1,075.00 Cu.Ft.: 33.30		
		INDIVIDUAL CARTON:		
		H: 22.50 W: 16.5 D: 3.00 Wt: 20.00 lbs		
OUT OF CARTON:		H: 22.50 W: 16.5 D: 3.00		
190204	SMOKEFIRE PELLETS - APPLE	\$30.99	\$34.99	
	<ul style="list-style-type: none"> <li>• 20 lb bag</li> <li>• Premium Hardwood Pellets</li> <li>• Mild flavour: aromatic, sweet</li> </ul>	50 BAGS PER PALLET		
		H: 28 W: 40 D: 48 Wt: 1,075.00 Cu.Ft.: 33.30		
		INDIVIDUAL CARTON:		
		H: 22.50 W: 16.5 D: 3.00 Wt: 20.00 lbs		
OUT OF CARTON:		H: 22.50 W: 16.5 D: 3.00		
7004	SMOKEFIRE WET SMOKE KIT	\$36.99	\$40.99	
	<ul style="list-style-type: none"> <li>• Adds moisture to the heat for enhanced wood fired flavour</li> <li>• Creates an indirect cooking space for grilling low-and-slow</li> <li>• Dual purpose design also supports grease management &amp; cleanup</li> <li>• Sits beneath the cooking grate for maximum grilling space</li> <li>• Includes 1 metal rack and 4 foil pans; additional pans sold separately #6416</li> </ul>	MASTER CARTON: 4		
		H: 13.87 W: 9.24 D: 12.88 Wt: 6.94 Cu.Ft.: 0.95		
		INDIVIDUAL CARTON:		
		H: 13.59 W: 9.65 D: 3.15 Wt: 1.47		
OUT OF CARTON:		H: 13 W: 7.6 D: 19.3		
7001	SMOKEFIRE FOLDING SIDE TABLE	\$115.99	\$126.99	
	<ul style="list-style-type: none"> <li>• Built-in bottle opener</li> <li>• Adds 200 square inches of work space and holds up to 40 lbs of food</li> <li>• Fits with the SMOKEFIRE Premium cover (sold separately) when table is folded up or down</li> <li>• Easily folds down when not in use and can be used for storing the WEBER cutting board (sold separately)</li> <li>• Attaches to left side of grill</li> </ul>	MASTER CARTON: 1		
		H: 3.82 W: 22.05 D: 13.75 Wt: 7.00 Cu.Ft.: 0.70		
		INDIVIDUAL CARTON:		
		H: 13.75 W: 22.05 D: 5.71 Wt: 7.00		
OUT OF CARTON:		H: 3.2 W: 12.3 D: 19.2		
7002	SMOKEFIRE EX4 FOLDING FRONT SHELF	\$115.99	\$126.99	
	<ul style="list-style-type: none"> <li>• Attaches to the front of SMOKEFIRE grill, adding 250+ square inches of work space and holds up to 20 lbs of food</li> <li>• Provides extra space for tools, platters, and cutting boards and folds down when not in use</li> <li>• Fits with the SMOKEFIRE Premium cover (sold separately) when table is folded up or down</li> <li>• Also designed to store the upper SMOKEFIRE grill cooking rack</li> </ul>	MASTER CARTON: 1		
		H: 4.00 W: 28.44 D: 10.00 Wt: 7.62 Cu.Ft.: 0.72		
		INDIVIDUAL CARTON:		
		H: 10.00 W: 28.44 D: 4.00 Wt: 7.62		
OUT OF CARTON:		H: 2.5 W: 26.5 D: 10.3		



## COOKING: PELLET ACCESSORIES

7003	<b>SMOKEFIRE EX6 FOLDING FRONT SHELF</b>	\$208.99	\$241.99	 <p>0 77924 15312 9</p>
 <ul style="list-style-type: none"> <li>Attaches to the front of <b>SMOKEFIRE</b> grill, adding 350+ square inches of work space and holds up to 20 lbs of food per shelf</li> <li>Provides extra space for tools, platters, and cutting boards and folds down when not in use</li> <li>Fits with the <b>SMOKEFIRE</b> Premium cover (sold separately) when table is folded up or down</li> <li>Also designed to store the upper <b>SMOKEFIRE</b> grill cooking rack</li> </ul>		<b>MASTER CARTON: 1</b>		
		H: 6.25 W: 21.00 D: 10.25 Wt: 13.50 Cu.Ft.: 0.80		
		<b>INDIVIDUAL CARTON:</b>		
		H: 6.42 W: 21.00 D: 10.25 Wt: 13.50		
<b>OUT OF CARTON:</b>		H: 2.5 W: 38.9 D: 10.3		



  

7009	<b>SMOKEFIRE GLOW PLUG (1 PCS)</b>	\$38.99	\$45.99	 <p>0 77924 16180 3</p>
 <ul style="list-style-type: none"> <li>Fits <b>SMOKEFIRE</b> EX4 and EX6 Wood Pellet Grills</li> </ul>		<b>MASTER CARTON: 12</b>		
		H: 5.19 W: 6.82 D: 11.57 Wt: 1.28 Cu.Ft.: 0.23		
		<b>INDIVIDUAL CARTON:</b>		
		H: 6.25 W: 2.75 D: 1.38 Wt: 1.00		
<b>OUT OF CARTON:</b>		H: 3.72 W: 0.47 D: 0.47		



## PREP AND SERVE: SPECIALTY ACCESSORIES

7031	<b>WEBER TRAVELER REVERSIBLE PREP &amp; SERVE</b>	\$49.99	\$54.99	 <p>0 77924 16051 6</p>
 <ul style="list-style-type: none"> <li>Form-fitted to the <b>WEBER TRAVELER</b> grill side table</li> <li>Reversible for prep and serve options</li> <li>Non-slip grips keep board in place during use</li> <li>Knife-friendly surface</li> <li>Juice groove to collect juices from foods</li> </ul>		<b>MASTER CARTON: 6</b>		
		H: 24.53 W: 8.86 D: 12.21 Wt: 10.07 Cu.Ft.: 1.54		
		<b>INDIVIDUAL CARTON:</b>		
		H: 9.3 W: 13.6 D: 0.4 Wt: 0.5		
<b>OUT OF CARTON:</b>		H: 0.52 W: 13.75 D: 9.48		

7032	<b>WEBER CUTTING BOARD WITH CATCH BIN</b>	\$49.99	\$54.99	 <p>0 77924 16052 3</p>
 <ul style="list-style-type: none"> <li>Perfect size for prepping on grill side tables</li> <li>Removable silicone catch bin collects chopped food or waste</li> <li>Juice groove collects liquids and prevents spills</li> <li>Silicone catch bin collapses for easy storage</li> <li>Hand wash recommended</li> </ul>		<b>MASTER CARTON: 6</b>		
		H: 13.0 W: 14.7 D: 8.8 Wt: 15.3 Cu.Ft.: 1.0		
		<b>INDIVIDUAL CARTON:</b>		
		H: 11.8 W: 13.6 D: 0.6 Wt: 2.3		
<b>OUT OF CARTON:</b>		H: 12.18 W: 13.81 D: 0.83		



7005	<b>WEBER CUTTING BOARD</b>	\$51.99	\$54.99	 <p>0 77924 15314 3</p>
 <ul style="list-style-type: none"> <li>Grooved edges catch meat juices for mess-free carving</li> <li>Perfect size for prepping &amp; serving on your <b>WEBER</b> grill side table</li> <li>Knife-friendly and dishwasher safe for easy cleanup</li> <li>Fits and stores in the <b>SMOKEFIRE</b> Folding Side Table accessory</li> </ul>		<b>MASTER CARTON: 6</b>		
		H: 11.42 W: 18.50 D: 6.50 Wt: 15.33 Cu.Ft.: 0.79		
		<b>INDIVIDUAL CARTON:</b>		
		H: 10.75 W: 17.72 D: 0.28 Wt: 2.34		
<b>OUT OF CARTON:</b>		H: 0.3 W: 17.6 D: 10.7		



# ACCESSORIES



MAP



MSRP



## PREP AND SERVE: SPECIALTY ACCESSORIES



<b>7696</b>	<b>FLOOR PROTECTION MAT</b>		\$59.99	\$65.99			
	<ul style="list-style-type: none"> <li>• Large surface area protects and covers the surface beneath your grill</li> <li>• Heat resistant and weather resistant</li> <li>• Anti-bacterial and quick drying</li> <li>• Smooth surface makes rolling up and storage easy</li> <li>• Compatible with a variety of grill sizes from an 18" kettle to a 4-burner gas grill</li> </ul>	<b>MASTER CARTON: 6</b>					
		<b>H:</b> 31.7	<b>W:</b> 6.8	<b>D:</b> 10.2		<b>Wt:</b> 3.3	<b>Cu.Ft.:</b> 1.3
		<b>INDIVIDUAL CARTON:</b>					
		<b>H:</b> 31.5	<b>W:</b> 3.2	<b>D:</b> 3.2	<b>Wt:</b> 0.6		
		<b>OUT OF CARTON:</b>					
		<b>H:</b> 0.1	<b>W:</b> 68.5	<b>D:</b> 47.2			

<b>7008</b>	<b>WEBER BUTCHER PAPER</b>		\$60.99	\$65.99			
	<ul style="list-style-type: none"> <li>• Use when smoking meats low-and-slow to retain moisture.</li> <li>• Food-grade butcher paper with food-grade ink, safe to be used on food</li> <li>• Unwaxed, uncoated, unbleached for food safety</li> <li>• 18 inches x 150 feet</li> </ul>	<b>MASTER CARTON: 1</b>					
		<b>H:</b> 4.00	<b>W:</b> 19.13	<b>D:</b> 3.82		<b>Wt:</b> 3.50	<b>Cu.Ft.:</b> 0.17
		<b>INDIVIDUAL CARTON:</b>					
		<b>H:</b> 4.00	<b>W:</b> 19.13	<b>D:</b> 3.82	<b>Wt:</b> 3.50		
		<b>OUT OF CARTON:</b>					
		<b>H:</b> 3.13	<b>W:</b> 18.00	<b>D:</b> 3.13			



<b>6691</b>	<b>PIZZA PADDLE</b>		\$60.99	\$65.99			
	<ul style="list-style-type: none"> <li>• Stainless steel paddle lifts and transports pizzas to and from the grill</li> <li>• Handle rotates for compact storage</li> </ul>	<b>MASTER CARTON: 4</b>					
		<b>H:</b> 7.75	<b>W:</b> 13.13	<b>D:</b> 16.07		<b>Wt:</b> 8.00	<b>Cu.Ft.:</b> 0.94
		<b>INDIVIDUAL CARTON:</b>					
		<b>H:</b> 15.00	<b>W:</b> 12.38	<b>D:</b> 1.75	<b>Wt:</b> 1.74		
		<b>OUT OF CARTON:</b>					
		<b>H:</b> 12.4	<b>W:</b> 24.8	<b>D:</b> 3.1			



<b>6483</b>	<b>BURGER PRESS</b>		\$20.99	\$22.99			
	<ul style="list-style-type: none"> <li>• Designed to make a dimple in patties for flat, uniform burgers</li> <li>• Press designed to make both 1/2 and 1/4 pound patties</li> <li>• Removable handle for easy storage</li> </ul>	<b>MASTER CARTON: 6</b>					
		<b>H:</b> 12.82	<b>W:</b> 6.07	<b>D:</b> 12.32		<b>Wt:</b> 3.40	<b>Cu.Ft.:</b> 0.55
		<b>INDIVIDUAL CARTON:</b>					
		<b>H:</b> 5.41	<b>W:</b> 5.11	<b>D:</b> 3.43	<b>Wt:</b> 0.48		
		<b>OUT OF CARTON:</b>					
		<b>H:</b> 5.5	<b>W:</b> 4.5	<b>D:</b> 3			



<b>6489</b>	<b>CORN HOLDER SET</b>		\$19.99	\$21.99			
	<ul style="list-style-type: none"> <li>• Nylon grip with thumb groove for secure and comfortable handling</li> <li>• Picks interlock for optimized storage in case</li> <li>• Stainless steel</li> <li>• Includes eight corn picks</li> </ul>	<b>MASTER CARTON: 4</b>					
		<b>H:</b> 8.38	<b>W:</b> 5.25	<b>D:</b> 5.25		<b>Wt:</b> 1.62	<b>Cu.Ft.:</b> 0.13
		<b>INDIVIDUAL CARTON:</b>					
		<b>H:</b> 5.57	<b>W:</b> 4.19	<b>D:</b> 1.04	<b>Wt:</b> 0.30		
		<b>OUT OF CARTON:</b>					
		<b>H:</b> 3.8	<b>W:</b> 0.6	<b>D:</b> 0.2			



<b>6488</b>	<b>POTATO NAILS</b>		\$19.99	\$21.99			
	<ul style="list-style-type: none"> <li>• Heat conducted through stainless steel nail provides quick and even cooking of potato</li> <li>• Includes tool for easy removal of nail from potato</li> <li>• Plastic case for easy storage</li> <li>• Set of six</li> </ul>	<b>MASTER CARTON: 4</b>					
		<b>H:</b> 7.50	<b>W:</b> 6.26	<b>D:</b> 4.07		<b>Wt:</b> 1.42	<b>Cu.Ft.:</b> 0.11
		<b>INDIVIDUAL CARTON:</b>					
		<b>H:</b> 4.72	<b>W:</b> 5.34	<b>D:</b> 0.84	<b>Wt:</b> 0.27		
		<b>OUT OF CARTON:</b>					
		<b>H:</b> 4.7	<b>W:</b> 0.6	<b>D:</b> 0.6			



## PREP AND SERVE: MITTS, GLOVES, AND APRONS



<b>6532</b>	<b>BARBECUE MITT</b>		\$19.99	\$21.99			
 <ul style="list-style-type: none"> <li>• Black mitt with red kettle embroidery</li> <li>• Foldable cuff adjusts length for fit</li> <li>• 100% cotton with heat-resistant liner</li> </ul>	<b>MASTER CARTON: 6</b>	<b>H:</b> 6.44	<b>W:</b> 7.69	<b>D:</b> 16.38		<b>Wt:</b> 3.68	<b>Cu.Ft.:</b> 0.46
	<b>INDIVIDUAL CARTON:</b>	<b>H:</b> 15.62	<b>W:</b> 2.75	<b>D:</b> 1.00		<b>Wt:</b> 0.42	
	<b>OUT OF CARTON:</b>	<b>H:</b> 15.8	<b>W:</b> 8.9	<b>D:</b> 0.8			

<b>6533</b>	<b>APRON</b>		\$29.99	\$31.99			
 <ul style="list-style-type: none"> <li>• Black apron, red kettle</li> <li>• Adjustable neckband for a customized fit</li> <li>• Deep front pocket for holding grilling tools</li> <li>• Front towel loop</li> <li>• Machine washable</li> <li>• One size fits most</li> </ul>	<b>MASTER CARTON: 6</b>	<b>H:</b> 11.13	<b>W:</b> 7.00	<b>D:</b> 8.00		<b>Wt:</b> 5.00	<b>Cu.Ft.:</b> 0.36
	<b>INDIVIDUAL CARTON:</b>	<b>H:</b> 10.50	<b>W:</b> 6.57	<b>D:</b> 1.38		<b>Wt:</b> 0.56	
	<b>OUT OF CARTON:</b>	<b>H:</b> 46.5	<b>W:</b> 25.4	<b>D:</b> 0.2			

<b>6534</b>	<b>APRON</b>		\$29.99	\$31.99			
 <ul style="list-style-type: none"> <li>• Red apron, black kettle</li> <li>• Adjustable neckband for a customized fit</li> <li>• Deep front pocket for holding grilling tools</li> <li>• Front towel loop</li> <li>• Machine washable</li> <li>• One size fits most</li> </ul>	<b>MASTER CARTON: 6</b>	<b>H:</b> 11.13	<b>W:</b> 7.00	<b>D:</b> 8.00		<b>Wt:</b> 5.00	<b>Cu.Ft.:</b> 0.36
	<b>INDIVIDUAL CARTON:</b>	<b>H:</b> 10.50	<b>W:</b> 6.57	<b>D:</b> 1.38		<b>Wt:</b> 0.56	
	<b>OUT OF CARTON:</b>	<b>H:</b> 46.5	<b>W:</b> 25.4	<b>D:</b> 0.2			

<b>6786</b>	<b>CROSSBACK APRON</b>	<b>Available Dec 2022</b>	\$59.99	\$64.99			
 <ul style="list-style-type: none"> <li>• 7 easy-access pockets, durable clothing protection and crossback straps for a comfortable fit.</li> </ul>	<b>MASTER CARTON: 6</b>	<b>H:</b> 7.48	<b>W:</b> 8.67	<b>D:</b> 12.21		<b>Wt:</b> 6.62	<b>Cu.Ft.:</b> 0.46
	<b>INDIVIDUAL CARTON:</b>	<b>H:</b> 6.79	<b>W:</b> 4.06	<b>D:</b> 3.86		<b>Wt:</b> 1.02	
	<b>OUT OF CARTON:</b>	<b>H:</b> 35.5	<b>W:</b> 26.5	<b>D:</b> 0.1			

<b>6535</b>	<b>PREMIUM GLOVES</b>		\$60.99	\$62.99			
 <ul style="list-style-type: none"> <li>• Silicone palm for gripping grilling tools</li> <li>• Flexible, heat resistant material for easy handling of grilling tools and grill lid</li> <li>• Size: L/XL</li> </ul>	<b>MASTER CARTON: 6</b>	<b>H:</b> 8.94	<b>W:</b> 6.19	<b>D:</b> 14.94		<b>Wt:</b> 3.62	<b>Cu.Ft.:</b> 0.47
	<b>INDIVIDUAL CARTON:</b>	<b>H:</b> 7.88	<b>W:</b> 5.25	<b>D:</b> 2.19		<b>Wt:</b> 0.49	
	<b>OUT OF CARTON:</b>	<b>H:</b> 13.5	<b>W:</b> 6.7	<b>D:</b> 0.3			







<b>7017</b>	<b>WEBER SILICONE GRILLING GLOVES</b>		\$30.99	\$34.99			
 <ul style="list-style-type: none"> <li>• Reusable</li> <li>• Food-grade and FDA compliant silicone</li> <li>• Easy-to-clean with soap and water, hand wash only</li> <li>• One size fits most</li> <li>• Heat resistant up to 400° Fahrenheit</li> </ul>	<b>MASTER CARTON: 6</b>	<b>H:</b> 11.19	<b>W:</b> 8.00	<b>D:</b> 5.71		<b>Wt:</b> 3.82	<b>Cu.Ft.:</b> 0.0
	<b>INDIVIDUAL CARTON:</b>	<b>H:</b> 10.2	<b>W:</b> 7.3	<b>D:</b> 0.8		<b>Wt:</b> 0.6	
	<b>OUT OF CARTON:</b>	<b>H:</b> 10.83	<b>W:</b> 7.68	<b>D:</b> N/A			

# ACCESSORIES







MAP

MSRP

## PREP AND SERVE: SMOKING ACCESSORIES

7576	SMOKER BOX	 <ul style="list-style-type: none"> <li>• Universal design for smoking on top of the cooking grates</li> <li>• Stainless steel</li> <li>• Fits <b>WEBER Q 200/2000</b> series and larger gas grills</li> </ul>	\$43.99	\$47.99	 0 77924 01120 7
			<b>MASTER CARTON: 4</b>		
			H: 11.00	W: 5.63	D: 11.38
			Wt: 6.76	Cu.Ft.: 0.40	
			<b>INDIVIDUAL CARTON:</b>		
			H: 9.82	W: 4.76	D: 2.44
			Wt: 1.46		
			<b>OUT OF CARTON:</b>		
			H: 9.7	W: 4.7	D: 2
17136	FIRESPICE PECAN WOOD CHIPS	 <p>Rich sweet flavour 192 cu. in. (0.003 m<sup>3</sup>)</p> 	\$8.99	\$9.99	 0 77924 05145 6
			<b>MASTER CARTON: 12</b>		
			H: 7.00	W: 19.00	D: 21.00
			Wt: 24.00	Cu.Ft.: 1.62	
			<b>INDIVIDUAL BAG:</b>		
			H: 12.50	W: 8.00	D: 2.50
			Wt: 2.00		
17137	FIRESPICE PECAN WOOD CHUNKS	 <p>Rich sweet flavour 350 cu. in. (0.006 m<sup>3</sup>)</p> 	\$13.99	\$15.99	 0 77924 05146 3
			<b>MASTER CARTON: 6</b>		
			H: 8.50	W: 15.00	D: 23.00
			Wt: 24.00	Cu.Ft.: 1.69	
			<b>INDIVIDUAL BAG:</b>		
			H: 16.00	W: 10.50	D: 4.00
			Wt: 4.00		
17138	FIRESPICE APPLE WOOD CHIPS	 <p>Subtle sweet flavour 192 cu. in. (0.003 m<sup>3</sup>)</p> 	\$8.99	\$9.99	 0 77924 05147 0
			<b>MASTER CARTON: 12</b>		
			H: 7.00	W: 19.00	D: 21.00
			Wt: 24.00	Cu.Ft.: 1.62	
			<b>INDIVIDUAL BAG:</b>		
			H: 12.50	W: 8.00	D: 2.50
			Wt: 2.00		
17139	FIRESPICE APPLE WOOD CHUNKS	 <p>Subtle sweet flavour 350 cu. in. (0.006 m<sup>3</sup>)</p> 	\$13.99	\$15.99	 0 77924 05148 7
			<b>MASTER CARTON: 6</b>		
			H: 8.50	W: 15.00	D: 23.00
			Wt: 24.00	Cu.Ft.: 1.69	
			<b>INDIVIDUAL BAG:</b>		
			H: 16.00	W: 10.50	D: 4.00
			Wt: 4.00		
17140	FIRESPICE CHERRY WOOD CHIPS	 <p>Subtle fruity flavour 192 cu. in. (0.003 m<sup>3</sup>)</p> 	\$8.99	\$9.99	 0 77924 05149 4
			<b>MASTER CARTON: 12</b>		
			H: 7.00	W: 19.00	D: 21.00
			Wt: 24.00	Cu.Ft.: 1.62	
			<b>INDIVIDUAL BAG:</b>		
			H: 12.50	W: 8.00	D: 2.50
			Wt: 2.00		

## PREP AND SERVE: SMOKING ACCESSORIES













17142	<b>FIRESPICE CHERRY WOOD CHUNKS</b>	\$13.99	\$15.99	 0 77924 05150 0
 	Subtle fruity flavour <b>350 cu. in. (0.006 m³)</b>	<b>MASTER CARTON: 6</b>		
		<b>H: 8.50 W: 15.00 D: 23.00 Wt: 24.00 Cu.Ft.: 1.69</b>		
		<b>INDIVIDUAL BAG:</b>		
		<b>H: 16.00 W: 10.50 D: 4.00 Wt: 4.00</b>		
17143	<b>FIRESPICE HICKORY WOOD CHIPS</b>	\$8.99	\$9.99	 0 77924 05151 7
 	Rich subtly sweet flavour <b>192 cu. in. (0.003 m³)</b>	<b>MASTER CARTON: 12</b>		
		<b>H: 7.00 W: 19.00 D: 21.00 Wt: 24.00 Cu.Ft.: 1.62</b>		
		<b>INDIVIDUAL BAG:</b>		
		<b>H: 12.50 W: 8.00 D: 2.50 Wt: 2.00</b>		
17148	<b>FIRESPICE HICKORY WOOD CHUNKS</b>	\$13.99	\$15.99	 0 77924 05152 4
 	Rich subtly sweet flavour <b>350 cu. in. (0.006 m³)</b>	<b>MASTER CARTON: 6</b>		
		<b>H: 8.50 W: 15.00 D: 23.00 Wt: 24.00 Cu.Ft.: 1.69</b>		
		<b>INDIVIDUAL BAG:</b>		
		<b>H: 16.00 W: 10.50 D: 4.00 Wt: 4.00</b>		
17149	<b>FIRESPICE MESQUITE WOOD CHIPS</b>	\$8.99	\$9.99	 0 77924 05153 1
 	Big bold flavour <b>192 cu. in. (0.003 m³)</b>	<b>MASTER CARTON: 12</b>		
		<b>H: 7.00 W: 19.00 D: 21.00 Wt: 24.00 Cu.Ft.: 1.62</b>		
		<b>INDIVIDUAL BAG:</b>		
		<b>H: 12.50 W: 8.00 D: 2.50 Wt: 2.00</b>		
17150	<b>FIRESPICE MESQUITE WOOD CHUNKS</b>	\$13.99	\$15.99	 0 77924 05155 5
 	Big bold flavour <b>350 cu. in. (0.006 m³)</b>	<b>MASTER CARTON: 6</b>		
		<b>H: 8.50 W: 15.00 D: 23.00 Wt: 24.00 Cu.Ft.: 1.69</b>		
		<b>INDIVIDUAL BAG:</b>		
		<b>H: 16.00 W: 10.50 D: 4.00 Wt: 4.00</b>		

# ACCESSORIES

MAP







MSRP

## CARE: BRUSHES





6275	WEBER 12" BAMBOO GRILL BRUSH	\$17.99	\$19.99																														
	<ul style="list-style-type: none"> <li>• Designed to easily and efficiently brush away residue</li> <li>• Angled bristle head increase distance from heat for safety</li> <li>• 12 in. long to reach all areas of the grate</li> <li>• Loop to hang brush for easy storage</li> <li>• Compliant to CSA Standards</li> <li>• 2-year warranty</li> </ul>	<table border="1"> <tr> <td colspan="5"><b>MASTER CARTON: 12</b></td> </tr> <tr> <td><b>H:</b> 12.4</td> <td><b>W:</b> 5.9</td> <td><b>D:</b> 10.4</td> <td><b>Wt:</b> 6.6</td> <td><b>Cu.Ft.:</b> 0.4</td> </tr> <tr> <td colspan="5"><b>INDIVIDUAL CARTON:</b></td> </tr> <tr> <td><b>H:</b> 11.7</td> <td><b>W:</b> 2.4</td> <td><b>D:</b> 0.5</td> <td><b>Wt:</b> 0.5</td> <td></td> </tr> <tr> <td colspan="5"><b>OUT OF CARTON:</b></td> </tr> <tr> <td><b>H:</b> 12.00</td> <td><b>W:</b> 2.25</td> <td><b>D:</b> 2.12</td> <td></td> <td></td> </tr> </table>		<b>MASTER CARTON: 12</b>					<b>H:</b> 12.4	<b>W:</b> 5.9	<b>D:</b> 10.4	<b>Wt:</b> 6.6	<b>Cu.Ft.:</b> 0.4	<b>INDIVIDUAL CARTON:</b>					<b>H:</b> 11.7	<b>W:</b> 2.4	<b>D:</b> 0.5	<b>Wt:</b> 0.5		<b>OUT OF CARTON:</b>					<b>H:</b> 12.00	<b>W:</b> 2.25	<b>D:</b> 2.12		
<b>MASTER CARTON: 12</b>																																	
<b>H:</b> 12.4	<b>W:</b> 5.9	<b>D:</b> 10.4	<b>Wt:</b> 6.6	<b>Cu.Ft.:</b> 0.4																													
<b>INDIVIDUAL CARTON:</b>																																	
<b>H:</b> 11.7	<b>W:</b> 2.4	<b>D:</b> 0.5	<b>Wt:</b> 0.5																														
<b>OUT OF CARTON:</b>																																	
<b>H:</b> 12.00	<b>W:</b> 2.25	<b>D:</b> 2.12																															
6276	WEBER 18" BAMBOO GRILL BRUSH	\$21.99	\$24.99																														
	<ul style="list-style-type: none"> <li>• Designed to easily and efficiently brush away residue</li> <li>• Angled bristle head increase distance from heat for safety</li> <li>• 18 in. long to reach all areas of the grate</li> <li>• Loop to hang brush for easy storage</li> <li>• Compliant to CSA Standards</li> <li>• 2-year warranty</li> </ul>	<table border="1"> <tr> <td colspan="5"><b>MASTER CARTON: 12</b></td> </tr> <tr> <td><b>H:</b> 18.7</td> <td><b>W:</b> 5.9</td> <td><b>D:</b> 10.4</td> <td><b>Wt:</b> 7.6</td> <td><b>Cu.Ft.:</b> 0.7</td> </tr> <tr> <td colspan="5"><b>INDIVIDUAL CARTON:</b></td> </tr> <tr> <td><b>H:</b> 17.7</td> <td><b>W:</b> 2.4</td> <td><b>D:</b> 2.1</td> <td><b>Wt:</b> 0.6</td> <td></td> </tr> <tr> <td colspan="5"><b>OUT OF CARTON:</b></td> </tr> <tr> <td><b>H:</b> 17.50</td> <td><b>W:</b> 2.25</td> <td><b>D:</b> 2.12</td> <td></td> <td></td> </tr> </table>		<b>MASTER CARTON: 12</b>					<b>H:</b> 18.7	<b>W:</b> 5.9	<b>D:</b> 10.4	<b>Wt:</b> 7.6	<b>Cu.Ft.:</b> 0.7	<b>INDIVIDUAL CARTON:</b>					<b>H:</b> 17.7	<b>W:</b> 2.4	<b>D:</b> 2.1	<b>Wt:</b> 0.6		<b>OUT OF CARTON:</b>					<b>H:</b> 17.50	<b>W:</b> 2.25	<b>D:</b> 2.12		
<b>MASTER CARTON: 12</b>																																	
<b>H:</b> 18.7	<b>W:</b> 5.9	<b>D:</b> 10.4	<b>Wt:</b> 7.6	<b>Cu.Ft.:</b> 0.7																													
<b>INDIVIDUAL CARTON:</b>																																	
<b>H:</b> 17.7	<b>W:</b> 2.4	<b>D:</b> 2.1	<b>Wt:</b> 0.6																														
<b>OUT OF CARTON:</b>																																	
<b>H:</b> 17.50	<b>W:</b> 2.25	<b>D:</b> 2.12																															
6277	WEBER 12" THREE-SIDED GRILL BRUSH	\$18.99	\$20.99																														
	<ul style="list-style-type: none"> <li>• 3-sided bristle brush design easily cleans larger areas quickly</li> <li>• Shorter sides clean edges and dislodge debris between grates</li> <li>• Comfort-hold handle for leverage when cleaning stuck on food</li> <li>• 12 in. long to reach all areas of the grate</li> <li>• Loop to hang brush for easy storage</li> <li>• 2-year warranty</li> </ul>	<table border="1"> <tr> <td colspan="5"><b>MASTER CARTON: 12</b></td> </tr> <tr> <td><b>H:</b> 13.6</td> <td><b>W:</b> 7.7</td> <td><b>D:</b> 17.6</td> <td><b>Wt:</b> 5.7</td> <td><b>Cu.Ft.:</b> 1.1</td> </tr> <tr> <td colspan="5"><b>INDIVIDUAL CARTON:</b></td> </tr> <tr> <td><b>H:</b> 12.3</td> <td><b>W:</b> 6.7</td> <td><b>D:</b> 1.4</td> <td><b>Wt:</b> 0.5</td> <td></td> </tr> <tr> <td colspan="5"><b>OUT OF CARTON:</b></td> </tr> <tr> <td><b>H:</b> 12.00</td> <td><b>W:</b> 7.00</td> <td><b>D:</b> 1.00</td> <td></td> <td></td> </tr> </table>		<b>MASTER CARTON: 12</b>					<b>H:</b> 13.6	<b>W:</b> 7.7	<b>D:</b> 17.6	<b>Wt:</b> 5.7	<b>Cu.Ft.:</b> 1.1	<b>INDIVIDUAL CARTON:</b>					<b>H:</b> 12.3	<b>W:</b> 6.7	<b>D:</b> 1.4	<b>Wt:</b> 0.5		<b>OUT OF CARTON:</b>					<b>H:</b> 12.00	<b>W:</b> 7.00	<b>D:</b> 1.00		
<b>MASTER CARTON: 12</b>																																	
<b>H:</b> 13.6	<b>W:</b> 7.7	<b>D:</b> 17.6	<b>Wt:</b> 5.7	<b>Cu.Ft.:</b> 1.1																													
<b>INDIVIDUAL CARTON:</b>																																	
<b>H:</b> 12.3	<b>W:</b> 6.7	<b>D:</b> 1.4	<b>Wt:</b> 0.5																														
<b>OUT OF CARTON:</b>																																	
<b>H:</b> 12.00	<b>W:</b> 7.00	<b>D:</b> 1.00																															
6278	WEBER 18" THREE-SIDED GRILL BRUSH	\$19.99	\$21.99																														
	<ul style="list-style-type: none"> <li>• 3-sided bristle brush design easily cleans larger areas quickly</li> <li>• Shorter sides clean edges and dislodge debris between grates</li> <li>• Comfort-hold handle for leverage when cleaning stuck on food</li> <li>• 18 in. long to reach all areas of the grate</li> <li>• Loop to hang brush for easy storage</li> <li>• 2-year warranty</li> </ul>	<table border="1"> <tr> <td colspan="5"><b>MASTER CARTON: 12</b></td> </tr> <tr> <td><b>H:</b> 19</td> <td><b>W:</b> 7.7</td> <td><b>D:</b> 17.6</td> <td><b>Wt:</b> 8.2</td> <td><b>Cu.Ft.:</b> 1.5</td> </tr> <tr> <td colspan="5"><b>INDIVIDUAL CARTON:</b></td> </tr> <tr> <td><b>H:</b> 17.9</td> <td><b>W:</b> 6.6</td> <td><b>D:</b> 1.4</td> <td><b>Wt:</b> 0.6</td> <td></td> </tr> <tr> <td colspan="5"><b>OUT OF CARTON:</b></td> </tr> <tr> <td><b>H:</b> 18.00</td> <td><b>W:</b> 7.00</td> <td><b>D:</b> 1.00</td> <td></td> <td></td> </tr> </table>		<b>MASTER CARTON: 12</b>					<b>H:</b> 19	<b>W:</b> 7.7	<b>D:</b> 17.6	<b>Wt:</b> 8.2	<b>Cu.Ft.:</b> 1.5	<b>INDIVIDUAL CARTON:</b>					<b>H:</b> 17.9	<b>W:</b> 6.6	<b>D:</b> 1.4	<b>Wt:</b> 0.6		<b>OUT OF CARTON:</b>					<b>H:</b> 18.00	<b>W:</b> 7.00	<b>D:</b> 1.00		
<b>MASTER CARTON: 12</b>																																	
<b>H:</b> 19	<b>W:</b> 7.7	<b>D:</b> 17.6	<b>Wt:</b> 8.2	<b>Cu.Ft.:</b> 1.5																													
<b>INDIVIDUAL CARTON:</b>																																	
<b>H:</b> 17.9	<b>W:</b> 6.6	<b>D:</b> 1.4	<b>Wt:</b> 0.6																														
<b>OUT OF CARTON:</b>																																	
<b>H:</b> 18.00	<b>W:</b> 7.00	<b>D:</b> 1.00																															
6279	WEBER 18" DETAIL BRUSH	\$16.99	\$18.99																														
	<ul style="list-style-type: none"> <li>• 18 in. handle helps reach and clean all areas of the grill</li> <li>• Comfort-hold handle for leverage when cleaning stuck on food</li> <li>• Loop to hang brush for easy storage</li> <li>• 2-year warranty</li> </ul>	<table border="1"> <tr> <td colspan="5"><b>MASTER CARTON: 12</b></td> </tr> <tr> <td><b>H:</b> 18.8</td> <td><b>W:</b> 5.2</td> <td><b>D:</b> 9.4</td> <td><b>Wt:</b> 7.1</td> <td><b>Cu.Ft.:</b> 0.5</td> </tr> <tr> <td colspan="5"><b>INDIVIDUAL CARTON:</b></td> </tr> <tr> <td><b>H:</b> 17.4</td> <td><b>W:</b> 2.2</td> <td><b>D:</b> 1.5</td> <td><b>Wt:</b> 0.5</td> <td></td> </tr> <tr> <td colspan="5"><b>OUT OF CARTON:</b></td> </tr> <tr> <td><b>H:</b> 17.50</td> <td><b>W:</b> 2.25</td> <td><b>D:</b> 1.00</td> <td></td> <td></td> </tr> </table>		<b>MASTER CARTON: 12</b>					<b>H:</b> 18.8	<b>W:</b> 5.2	<b>D:</b> 9.4	<b>Wt:</b> 7.1	<b>Cu.Ft.:</b> 0.5	<b>INDIVIDUAL CARTON:</b>					<b>H:</b> 17.4	<b>W:</b> 2.2	<b>D:</b> 1.5	<b>Wt:</b> 0.5		<b>OUT OF CARTON:</b>					<b>H:</b> 17.50	<b>W:</b> 2.25	<b>D:</b> 1.00		
<b>MASTER CARTON: 12</b>																																	
<b>H:</b> 18.8	<b>W:</b> 5.2	<b>D:</b> 9.4	<b>Wt:</b> 7.1	<b>Cu.Ft.:</b> 0.5																													
<b>INDIVIDUAL CARTON:</b>																																	
<b>H:</b> 17.4	<b>W:</b> 2.2	<b>D:</b> 1.5	<b>Wt:</b> 0.5																														
<b>OUT OF CARTON:</b>																																	
<b>H:</b> 17.50	<b>W:</b> 2.25	<b>D:</b> 1.00																															
7462	WOOD GRILL SCRAPER	\$38.99	\$41.99																														
	<ul style="list-style-type: none"> <li>• Conforms to grates for efficient removal of buildup and residue</li> <li>• Specially designed for easy handling</li> <li>• Made of durable hardwood</li> <li>• Thick, heavy-duty scraper edge for long-lasting use</li> <li>• Fits different grate types</li> </ul>	<table border="1"> <tr> <td colspan="5"><b>MASTER CARTON: 6</b></td> </tr> <tr> <td><b>H:</b> 7.68</td> <td><b>W:</b> 6.93</td> <td><b>D:</b> 19.61</td> <td><b>Wt:</b> 6.06</td> <td><b>Cu.Ft.:</b> 0.60</td> </tr> <tr> <td colspan="5"><b>INDIVIDUAL CARTON:</b></td> </tr> <tr> <td><b>H:</b> 17.83</td> <td><b>W:</b> 5.59</td> <td><b>D:</b> 0.79</td> <td><b>Wt:</b> 1.23</td> <td></td> </tr> <tr> <td colspan="5"><b>OUT OF CARTON:</b></td> </tr> <tr> <td><b>H:</b> 17.83</td> <td><b>W:</b> 5.59</td> <td><b>D:</b> 0.79</td> <td></td> <td></td> </tr> </table>		<b>MASTER CARTON: 6</b>					<b>H:</b> 7.68	<b>W:</b> 6.93	<b>D:</b> 19.61	<b>Wt:</b> 6.06	<b>Cu.Ft.:</b> 0.60	<b>INDIVIDUAL CARTON:</b>					<b>H:</b> 17.83	<b>W:</b> 5.59	<b>D:</b> 0.79	<b>Wt:</b> 1.23		<b>OUT OF CARTON:</b>					<b>H:</b> 17.83	<b>W:</b> 5.59	<b>D:</b> 0.79		
<b>MASTER CARTON: 6</b>																																	
<b>H:</b> 7.68	<b>W:</b> 6.93	<b>D:</b> 19.61	<b>Wt:</b> 6.06	<b>Cu.Ft.:</b> 0.60																													
<b>INDIVIDUAL CARTON:</b>																																	
<b>H:</b> 17.83	<b>W:</b> 5.59	<b>D:</b> 0.79	<b>Wt:</b> 1.23																														
<b>OUT OF CARTON:</b>																																	
<b>H:</b> 17.83	<b>W:</b> 5.59	<b>D:</b> 0.79																															



## CARE: DRIP PANS

6415	DRIP PANS		\$13.99	\$15.99	 0 77924 07475 2
 <ul style="list-style-type: none"> <li>Foil liners for grease catch pan</li> <li>10 pans per pack</li> <li>Fits <b>WEBER Q</b> grills, <b>WEBER TRAVELER</b>, <b>SPIRIT</b> gas grills, <b>SPIRIT II</b> gas grills, <b>GENESIS</b> gas grills, <b>GENESIS II 200</b> and <b>300</b> series gas grills</li> </ul>			<b>MASTER CARTON: 10</b> H: 9.57 W: 12.69 D: 9.69 Wt: 4.00 Cu.Ft.: 0.68		
			<b>INDIVIDUAL CARTON:</b> H: 10.00 W: 6 D: 2.50 Wt: 0.32		
			<b>OUT OF CARTON:</b> H: 8.6 W: 6.0 D: 1.3		
6498	DRIP PANS		\$20.99	\$23.99	 0 77924 12981 0
 <ul style="list-style-type: none"> <li>Foil liners for grease catch pan</li> <li>10 pans per pack</li> <li>Fits <b>SMOKEFIRE</b> grills, <b>GENESIS II 400</b> and <b>600</b> series gas grills, <b>SUMMIT 400/600</b> series, and <b>SUMMIT Gold/Platinum 6-burner</b> models</li> </ul>			<b>MASTER CARTON: 4</b> H: 11.82 W: 5.57 D: 11.94 Wt: 4.06 Cu.Ft.: 0.45		
			<b>INDIVIDUAL CARTON:</b> H: 11.38 W: 4.75 D: 2.86 Wt: 1.02		
			<b>OUT OF CARTON:</b> H: 11 W: 5.0 D: 2.5		
6416	FOIL PANS		\$17.99	\$19.99	 0 77924 07476 9
 <ul style="list-style-type: none"> <li>Disposable pans for transporting food to and from the grill</li> <li>Use with rotisseries, roast racks, or between <b>CHAR-BASKETS</b> for indirect cooking</li> <li>Fits <b>SMOKEFIRE</b> Wet Smoke Kit</li> <li>10 pans per pack</li> </ul>			<b>MASTER CARTON: 6</b> H: 14.07 W: 9.94 D: 13.69 Wt: 6.00 Cu.Ft.: 1.10		
			<b>INDIVIDUAL CARTON:</b> H: 13.19 W: 9.32 D: 3.50 Wt: 0.80		
			<b>OUT OF CARTON:</b> H: 13.1 W: 9.1 D: 2		

## CARE: COVERS - TRAVELER



7770	PREMIUM GRILL COVER	Available Now	\$79.99	\$89.99	 0 77924 19404 7
 <ul style="list-style-type: none"> <li>Weather-resistant fabric shields your grill from rain and snow</li> <li>Made from durable, polyester material</li> <li>Lightweight design makes covering and uncovering easy</li> <li>Compatible with <b>WEBER TRAVELER</b> grill</li> <li>Fastening straps keep the cover secure once in place</li> </ul>			<b>MASTER CARTON: 4</b> H: 11.7 W: 10.65 D: 8.15 Wt: 7.9 Cu.Ft.: 0.59		
			<b>INDIVIDUAL CARTON:</b> H: 11.2 W: 7.35 D: 2.7 Wt: 1.65		
			<b>OUT OF CARTON:</b> H: 39.3 W: 22.0 D: 56.6		
7030	WEBER TRAVELER CARGO PROTECTOR		\$87.99	\$98.99	 0 77924 16050 9
 <ul style="list-style-type: none"> <li>Form-fitted to the <b>WEBER TRAVELER</b> grill for optimal grease and grime containment</li> <li>Grease-resistant fabric protects trunk interior or cargo space</li> <li>Integrated storage pockets for grilling tools</li> <li>Folds flat and small for compact storage</li> </ul>			<b>MASTER CARTON: 4</b> H: 20.99 W: 8.04 D: 12.41 Wt: 6.99 Cu.Ft.: 1.21		
			<b>INDIVIDUAL CARTON:</b> H: 10.00 W: 7.3 D: 2.7 Wt: 1.6		
			<b>OUT OF CARTON:</b> H: 13.81 W: 40.55 D: 23.00		



# ACCESSORIES



MAP

MSRP



## CARE: COVERS - GRIDDLES



<b>7035</b>	<b>GRIDDLE STORAGE BAG 3B</b>	<b>Available Feb 2023</b>	<b>\$69.99</b>	<b>\$76.99</b>	 0 77924 19938 7				
 	<ul style="list-style-type: none"> <li>Storage bag for full-size griddle when not in use</li> <li>Fits 6787 <b>SPIRIT FULL-SIZE GRIDDLE</b> and 6788 <b>GENESIS FULL-SIZE GRIDDLE</b></li> </ul>	<b>MASTER CARTON: 4</b>	<b>H: 10.65</b>	<b>W: 8.15</b>		<b>D: 11.7</b>	<b>Wt: 5.3</b>	<b>Cu.Ft.: 0.58</b>	
		<b>INDIVIDUAL CARTON:</b>	<b>H: 10.1</b>	<b>W: 7.25</b>		<b>D: 2.65</b>	<b>Wt: 1.32</b>		
		<b>OUT OF CARTON:</b>	<b>H: 19.0</b>	<b>W: 27.0</b>		<b>D: 2.0</b>			

<b>7036</b>	<b>GRIDDLE STORAGE BAG 4B</b>	<b>Available Feb 2023</b>	<b>\$84.99</b>	<b>\$94.99</b>	 0 77924 19939 4				
 	<ul style="list-style-type: none"> <li>Storage bag for full-size griddle when not in use</li> <li>Fits 6789 <b>GENESIS FULL-SIZE GRIDDLE</b></li> </ul>	<b>MASTER CARTON: 4</b>	<b>H: 10.65</b>	<b>W: 8.15</b>		<b>D: 11.7</b>	<b>Wt: 5.3</b>	<b>Cu.Ft.: 0.58</b>	
		<b>INDIVIDUAL CARTON:</b>	<b>H: 10.1</b>	<b>W: 7.25</b>		<b>D: 2.65</b>	<b>Wt: 1.32</b>		
		<b>OUT OF CARTON:</b>	<b>H: 19.0</b>	<b>W: 34.0</b>		<b>D: 2.0</b>			













<b>7771</b>	<b>PREMIUM GRIDDLE COVER</b>	<b>Available Feb 2023</b>	<b>\$139.99</b>	<b>\$149.99</b>	 0 77924 19664 5				
 	<ul style="list-style-type: none"> <li>UV inhibitors in fabric resist fading</li> <li>Breathable and water resistant to help protect grill from the elements</li> <li>Fastening straps keep the cover in place</li> <li>Fits <b>WEBER GRIDDLE G28</b> gas grills</li> </ul>	<b>MASTER CARTON: 4</b>	<b>H: 10.65</b>	<b>W: 8.15</b>		<b>D: 11.7</b>	<b>Wt: 5.3</b>	<b>Cu.Ft.: 0.59</b>	
		<b>INDIVIDUAL CARTON:</b>	<b>H: 11.2</b>	<b>W: 7.35</b>		<b>D: 2.7</b>	<b>Wt: 1.0</b>		
		<b>OUT OF CARTON:</b>	<b>H: 43.4</b>	<b>W: 63.0</b>		<b>D: 25.6</b>			

## CARE: COVERS - PELLET

<b>7190</b>	<b>PREMIUM GRILL COVER</b>		<b>\$104.99</b>	<b>\$115.99</b>	 0 77924 12965 0				
	<ul style="list-style-type: none"> <li>UV inhibitors in fabric resist fading</li> <li>Breathable and water resistant to help protect grill from the elements</li> <li>Fastening straps keep the cover in place</li> <li>Fits <b>SMOKEFIRE EX4/EPX4</b> Wood Pellet grills</li> </ul>	<b>MASTER CARTON: 3</b>	<b>H: 10.63</b>	<b>W: 8.23</b>		<b>D: 11.62</b>	<b>Wt: 8.21</b>	<b>Cu.Ft.: 0.58</b>	
		<b>INDIVIDUAL CARTON:</b>	<b>H: 9.63</b>	<b>W: 7.26</b>		<b>D: 3.55</b>	<b>Wt: 2.50</b>		
		<b>OUT OF CARTON:</b>	<b>H: 43.3</b>	<b>W: 58.3</b>		<b>D: 32.1</b>			

<b>7191</b>	<b>PREMIUM GRILL COVER</b>		<b>\$126.99</b>	<b>\$137.99</b>	 0 77924 12966 7				
	<ul style="list-style-type: none"> <li>UV inhibitors in fabric resist fading</li> <li>Breathable and water resistant to help protect grill from the elements</li> <li>Fastening straps keep the cover in place</li> <li>Fits <b>SMOKEFIRE EX6/EPX6</b> Wood Pellet grills</li> </ul>	<b>MASTER CARTON: 2</b>	<b>H: 10.44</b>	<b>W: 7.94</b>		<b>D: 8.81</b>	<b>Wt: 6.38</b>	<b>Cu.Ft.: 0.42</b>	
		<b>INDIVIDUAL CARTON:</b>	<b>H: 10.25</b>	<b>W: 4.00</b>		<b>D: 7.30</b>	<b>Wt: 2.80</b>		
		<b>OUT OF CARTON:</b>	<b>H: 41.8</b>	<b>W: 69.2</b>		<b>D: 32.1</b>			

## CARE: COVERS - GAS











7110	GRILL COVER	 <ul style="list-style-type: none"> <li>• UV inhibitors in fabric resist fading</li> <li>• Breathable and water resistant to help protect grill from the elements</li> <li>• Drawstring keeps the cover in place</li> <li>• Fits <b>WEBER Q</b> 100/1000 series grills</li> </ul>	<p>\$29.99      \$31.99</p> <p><b>MASTER CARTON: 4</b></p> <p>H: 4.63    W: 10.94    D: 9.50    Wt: 2.43    Cu.Ft.: 0.27</p> <p><b>INDIVIDUAL CARTON:</b></p> <p>H: 7.50    W: 3.94    D: 2.50    Wt: 0.45</p> <p><b>OUT OF CARTON:</b></p> <p>H: 12.4    W: 26.3    D: 17.3</p>	 <p>0 77924 03545 6</p>
7111	GRILL COVER	 <ul style="list-style-type: none"> <li>• UV inhibitors in fabric resist fading</li> <li>• Breathable and water resistant to help protect grill from the elements</li> <li>• Drawstring keeps the cover in place</li> <li>• Fits <b>WEBER Q</b> 200/2000 series grills</li> </ul>	<p>\$32.99      \$36.99</p> <p><b>MASTER CARTON: 4</b></p> <p>H: 4.63    W: 10.94    D: 9.50    Wt: 2.62    Cu.Ft.: 0.27</p> <p><b>INDIVIDUAL CARTON:</b></p> <p>H: 7.50    W: 3.94    D: 2.50    Wt: 0.52</p> <p><b>OUT OF CARTON:</b></p> <p>H: 12.6    W: 32.3    D: 18.9</p>	 <p>0 77924 03546 3</p>
7112	PREMIUM GRILL COVER	 <ul style="list-style-type: none"> <li>• UV inhibitors in fabric resist fading</li> <li>• Breathable and water resistant to help protect grill from the elements</li> <li>• Fastening straps keep the cover in place</li> <li>• Fits <b>WEBER Q</b> 2000 series grills with Q cart and <b>WEBER Q</b> 3000 series grills</li> </ul>	<p>\$71.99      \$76.99</p> <p><b>MASTER CARTON: 4</b></p> <p>H: 10.63    W: 8.13    D: 11.69    Wt: 5.00    Cu.Ft.: 0.58</p> <p><b>INDIVIDUAL CARTON:</b></p> <p>H: 11.19    W: 7.32    D: 2.69    Wt: 1.95</p> <p><b>OUT OF CARTON:</b></p> <p>H: 56.6    W: 39.3    D: 22</p>	 <p>0 77924 03547 0</p>
7113	PREMIUM GRILL COVER	 <ul style="list-style-type: none"> <li>• UV inhibitors in fabric resist fading</li> <li>• Breathable and water resistant to help protect grill from the elements</li> <li>• Fastening straps keep the cover in place</li> <li>• Fits <b>WEBER Q</b> 100/1000 and <b>WEBER Q</b> 200/2000 grills with the <b>Q</b> portable cart</li> </ul>	<p>\$60.99      \$68.99</p> <p><b>MASTER CARTON: 4</b></p> <p>H: 10.63    W: 8.13    D: 11.69    Wt: 6.74    Cu.Ft.: 0.58</p> <p><b>INDIVIDUAL CARTON:</b></p> <p>H: 11.19    W: 7.32    D: 2.69    Wt: 1.31</p> <p><b>OUT OF CARTON:</b></p> <p>H: 32.2    W: 35    D: 17.3</p>	 <p>0 77924 03548 7</p>
7137	TANK COVER	 <ul style="list-style-type: none"> <li>• UV inhibitors in fabric resist fading</li> <li>• Breathable, weather resistant fabric</li> <li>• Protects cylinder from the elements</li> <li>• Drawstring keeps the cover in place</li> <li>• Fits standard size 20 lb. LP tank (tank sold separately)</li> </ul>	<p>\$20.99      \$23.99</p> <p><b>MASTER CARTON: 4</b></p> <p>H: 9.5    W: 10.9    D: 4.6    Wt: 2.25    Cu.Ft.: 0.3</p> <p><b>INDIVIDUAL CARTON:</b></p> <p>H: 8.75    W: 4.00    D: 2.5    Wt: 0.40</p> <p><b>OUT OF CARTON:</b></p> <p>H: 16.5    W: 13.9    D: 13.9</p>	 <p>0 77924 05199 9</p>
7138	PREMIUM GRILL COVER	 <ul style="list-style-type: none"> <li>• UV inhibitors in fabric resist fading</li> <li>• Breathable and water resistant to help protect grill from the elements</li> <li>• Fastening straps keep the cover in place</li> <li>• Fits <b>SPIRIT</b> 200 and <b>SPIRIT II</b> 200 series gas grills</li> </ul>	<p>\$98.99      \$109.99</p> <p><b>MASTER CARTON: 3</b></p> <p>H: 10.63    W: 8.13    D: 13.13    Wt: 6.83    Cu.Ft.: 0.65</p> <p><b>INDIVIDUAL CARTON:</b></p> <p>H: 11.25    W: 7.25    D: 4.00    Wt: 2.18</p> <p><b>OUT OF CARTON:</b></p> <p>H: 42    W: 48    D: 27</p>	 <p>0 77924 05874 5</p>

# ACCESSORIES

MAP

MSRP

## CARE: COVERS - GAS GRILL

7139	PREMIUM GRILL COVER	\$109.99	\$120.99																														
	<ul style="list-style-type: none"> <li>• UV inhibitors in fabric resist fading</li> <li>• Breathable and water resistant to help protect grill from the elements</li> <li>• Fastening straps keep the cover in place</li> <li>• Fits <b>SPIRIT 300</b> and <b>SPIRIT II 300</b> series gas grills</li> </ul>	<table border="1"> <tr> <td colspan="5"><b>MASTER CARTON: 3</b></td> </tr> <tr> <td><b>H:</b> 10.63</td> <td><b>W:</b> 8.07</td> <td><b>D:</b> 13.13</td> <td><b>Wt:</b> 9.09</td> <td><b>Cu.Ft.:</b> 0.65</td> </tr> <tr> <td colspan="5"><b>INDIVIDUAL CARTON:</b></td> </tr> <tr> <td><b>H:</b> 11.25</td> <td><b>W:</b> 7.25</td> <td><b>D:</b> 4.00</td> <td><b>Wt:</b> 2.30</td> <td></td> </tr> <tr> <td colspan="5"><b>OUT OF CARTON:</b></td> </tr> <tr> <td><b>H:</b> 42</td> <td><b>W:</b> 52</td> <td><b>D:</b> 27</td> <td></td> <td></td> </tr> </table>		<b>MASTER CARTON: 3</b>					<b>H:</b> 10.63	<b>W:</b> 8.07	<b>D:</b> 13.13	<b>Wt:</b> 9.09	<b>Cu.Ft.:</b> 0.65	<b>INDIVIDUAL CARTON:</b>					<b>H:</b> 11.25	<b>W:</b> 7.25	<b>D:</b> 4.00	<b>Wt:</b> 2.30		<b>OUT OF CARTON:</b>					<b>H:</b> 42	<b>W:</b> 52	<b>D:</b> 27		
<b>MASTER CARTON: 3</b>																																	
<b>H:</b> 10.63	<b>W:</b> 8.07	<b>D:</b> 13.13	<b>Wt:</b> 9.09	<b>Cu.Ft.:</b> 0.65																													
<b>INDIVIDUAL CARTON:</b>																																	
<b>H:</b> 11.25	<b>W:</b> 7.25	<b>D:</b> 4.00	<b>Wt:</b> 2.30																														
<b>OUT OF CARTON:</b>																																	
<b>H:</b> 42	<b>W:</b> 52	<b>D:</b> 27																															
7757	PREMIUM GRILL COVER	\$131.99	\$142.99																														
	<ul style="list-style-type: none"> <li>• UV inhibitors in fabric resist fading</li> <li>• Breathable and water resistant to help protect grill from the elements</li> <li>• Fastening straps keep the cover in place</li> <li>• Fits <b>GENESIS II 300</b> series gas grills, and <b>GENESIS 300</b> series gas grills</li> </ul>	<table border="1"> <tr> <td colspan="5"><b>MASTER CARTON: 2</b></td> </tr> <tr> <td><b>H:</b> 10.63</td> <td><b>W:</b> 8.07</td> <td><b>D:</b> 10.19</td> <td><b>Wt:</b> 8.44</td> <td><b>Cu.Ft.:</b> 0.50</td> </tr> <tr> <td colspan="5"><b>INDIVIDUAL CARTON:</b></td> </tr> <tr> <td><b>H:</b> 11.25</td> <td><b>W:</b> 7.25</td> <td><b>D:</b> 3.00</td> <td><b>Wt:</b> 2.43</td> <td></td> </tr> <tr> <td colspan="5"><b>OUT OF CARTON:</b></td> </tr> <tr> <td><b>H:</b> 44.5</td> <td><b>W:</b> 59</td> <td><b>D:</b> 29</td> <td></td> <td></td> </tr> </table>		<b>MASTER CARTON: 2</b>					<b>H:</b> 10.63	<b>W:</b> 8.07	<b>D:</b> 10.19	<b>Wt:</b> 8.44	<b>Cu.Ft.:</b> 0.50	<b>INDIVIDUAL CARTON:</b>					<b>H:</b> 11.25	<b>W:</b> 7.25	<b>D:</b> 3.00	<b>Wt:</b> 2.43		<b>OUT OF CARTON:</b>					<b>H:</b> 44.5	<b>W:</b> 59	<b>D:</b> 29		
<b>MASTER CARTON: 2</b>																																	
<b>H:</b> 10.63	<b>W:</b> 8.07	<b>D:</b> 10.19	<b>Wt:</b> 8.44	<b>Cu.Ft.:</b> 0.50																													
<b>INDIVIDUAL CARTON:</b>																																	
<b>H:</b> 11.25	<b>W:</b> 7.25	<b>D:</b> 3.00	<b>Wt:</b> 2.43																														
<b>OUT OF CARTON:</b>																																	
<b>H:</b> 44.5	<b>W:</b> 59	<b>D:</b> 29																															
7758	PREMIUM GRILL COVER	\$142.99	\$158.99																														
	<ul style="list-style-type: none"> <li>• UV inhibitors in fabric resist fading</li> <li>• Breathable and water resistant to help protect grill from the elements</li> <li>• Fastening straps keep the cover in place</li> <li>• Fits <b>GENESIS II 400</b> series gas grills</li> </ul>	<table border="1"> <tr> <td colspan="5"><b>MASTER CARTON: 2</b></td> </tr> <tr> <td><b>H:</b> 10.63</td> <td><b>W:</b> 8.13</td> <td><b>D:</b> 9.00</td> <td><b>Wt:</b> 6.32</td> <td><b>Cu.Ft.:</b> 0.45</td> </tr> <tr> <td colspan="5"><b>INDIVIDUAL CARTON:</b></td> </tr> <tr> <td><b>H:</b> 11.25</td> <td><b>W:</b> 7.25</td> <td><b>D:</b> 4.00</td> <td><b>Wt:</b> 2.82</td> <td></td> </tr> <tr> <td colspan="5"><b>OUT OF CARTON:</b></td> </tr> <tr> <td><b>H:</b> 44.5</td> <td><b>W:</b> 65</td> <td><b>D:</b> 29</td> <td></td> <td></td> </tr> </table>		<b>MASTER CARTON: 2</b>					<b>H:</b> 10.63	<b>W:</b> 8.13	<b>D:</b> 9.00	<b>Wt:</b> 6.32	<b>Cu.Ft.:</b> 0.45	<b>INDIVIDUAL CARTON:</b>					<b>H:</b> 11.25	<b>W:</b> 7.25	<b>D:</b> 4.00	<b>Wt:</b> 2.82		<b>OUT OF CARTON:</b>					<b>H:</b> 44.5	<b>W:</b> 65	<b>D:</b> 29		
<b>MASTER CARTON: 2</b>																																	
<b>H:</b> 10.63	<b>W:</b> 8.13	<b>D:</b> 9.00	<b>Wt:</b> 6.32	<b>Cu.Ft.:</b> 0.45																													
<b>INDIVIDUAL CARTON:</b>																																	
<b>H:</b> 11.25	<b>W:</b> 7.25	<b>D:</b> 4.00	<b>Wt:</b> 2.82																														
<b>OUT OF CARTON:</b>																																	
<b>H:</b> 44.5	<b>W:</b> 65	<b>D:</b> 29																															
7108	PREMIUM GRILL COVER	\$164.99	\$186.99																														
	<ul style="list-style-type: none"> <li>• UV inhibitors in fabric resist fading</li> <li>• Breathable and water resistant to help protect grill from the elements</li> <li>• Fastening straps keep the cover in place</li> <li>• Fits <b>SUMMIT 400</b> series gas grills</li> </ul>	<table border="1"> <tr> <td colspan="5"><b>MASTER CARTON: 2</b></td> </tr> <tr> <td><b>H:</b> 10.57</td> <td><b>W:</b> 8.19</td> <td><b>D:</b> 11.57</td> <td><b>Wt:</b> 6.00</td> <td><b>Cu.Ft.:</b> 0.57</td> </tr> <tr> <td colspan="5"><b>INDIVIDUAL CARTON:</b></td> </tr> <tr> <td><b>H:</b> 11.25</td> <td><b>W:</b> 7.25</td> <td><b>D:</b> 5.25</td> <td><b>Wt:</b> 2.18</td> <td></td> </tr> <tr> <td colspan="5"><b>OUT OF CARTON:</b></td> </tr> <tr> <td><b>H:</b> 47</td> <td><b>W:</b> 66.8</td> <td><b>D:</b> 26.8</td> <td></td> <td></td> </tr> </table>		<b>MASTER CARTON: 2</b>					<b>H:</b> 10.57	<b>W:</b> 8.19	<b>D:</b> 11.57	<b>Wt:</b> 6.00	<b>Cu.Ft.:</b> 0.57	<b>INDIVIDUAL CARTON:</b>					<b>H:</b> 11.25	<b>W:</b> 7.25	<b>D:</b> 5.25	<b>Wt:</b> 2.18		<b>OUT OF CARTON:</b>					<b>H:</b> 47	<b>W:</b> 66.8	<b>D:</b> 26.8		
<b>MASTER CARTON: 2</b>																																	
<b>H:</b> 10.57	<b>W:</b> 8.19	<b>D:</b> 11.57	<b>Wt:</b> 6.00	<b>Cu.Ft.:</b> 0.57																													
<b>INDIVIDUAL CARTON:</b>																																	
<b>H:</b> 11.25	<b>W:</b> 7.25	<b>D:</b> 5.25	<b>Wt:</b> 2.18																														
<b>OUT OF CARTON:</b>																																	
<b>H:</b> 47	<b>W:</b> 66.8	<b>D:</b> 26.8																															
7109	PREMIUM GRILL COVER	\$164.99	\$186.99																														
	<ul style="list-style-type: none"> <li>• UV inhibitors in fabric resist fading</li> <li>• Breathable and water resistant to help protect grill from the elements</li> <li>• Fastening straps keep the cover in place</li> <li>• Fits <b>SUMMIT 600</b> series gas grills</li> </ul>	<table border="1"> <tr> <td colspan="5"><b>MASTER CARTON: 2</b></td> </tr> <tr> <td><b>H:</b> 10.57</td> <td><b>W:</b> 8.19</td> <td><b>D:</b> 11.57</td> <td><b>Wt:</b> 7.92</td> <td><b>Cu.Ft.:</b> 0.57</td> </tr> <tr> <td colspan="5"><b>INDIVIDUAL CARTON:</b></td> </tr> <tr> <td><b>H:</b> 11.25</td> <td><b>W:</b> 7.25</td> <td><b>D:</b> 5.25</td> <td><b>Wt:</b> 3.21</td> <td></td> </tr> <tr> <td colspan="5"><b>OUT OF CARTON:</b></td> </tr> <tr> <td><b>H:</b> 47</td> <td><b>W:</b> 74.8</td> <td><b>D:</b> 26.8</td> <td></td> <td></td> </tr> </table>		<b>MASTER CARTON: 2</b>					<b>H:</b> 10.57	<b>W:</b> 8.19	<b>D:</b> 11.57	<b>Wt:</b> 7.92	<b>Cu.Ft.:</b> 0.57	<b>INDIVIDUAL CARTON:</b>					<b>H:</b> 11.25	<b>W:</b> 7.25	<b>D:</b> 5.25	<b>Wt:</b> 3.21		<b>OUT OF CARTON:</b>					<b>H:</b> 47	<b>W:</b> 74.8	<b>D:</b> 26.8		
<b>MASTER CARTON: 2</b>																																	
<b>H:</b> 10.57	<b>W:</b> 8.19	<b>D:</b> 11.57	<b>Wt:</b> 7.92	<b>Cu.Ft.:</b> 0.57																													
<b>INDIVIDUAL CARTON:</b>																																	
<b>H:</b> 11.25	<b>W:</b> 7.25	<b>D:</b> 5.25	<b>Wt:</b> 3.21																														
<b>OUT OF CARTON:</b>																																	
<b>H:</b> 47	<b>W:</b> 74.8	<b>D:</b> 26.8																															

## CARE: COVERS - CHARCOAL GRILL



7154	SMOKEY JOE BAG	 <ul style="list-style-type: none"> <li>• Comes with an adjustable, padded shoulder strap</li> <li>• Fits <b>SMOKEY JOE</b> and <b>SMOKEY JOE Premium</b> portable grills</li> </ul>	<p>\$51.99      \$56.99</p> <p><b>MASTER CARTON: 2</b></p> <p>H: 9.94    W: 8.68    D: 5.19    Wt: 2.15    Cu.Ft.: 0.25</p> <p><b>INDIVIDUAL CARTON:</b></p> <p>H: 9.13    W: 8.00    D: 2.25    Wt: 0.92</p> <p><b>OUT OF CARTON:</b></p> <p>H: 19.6    W: 18.9    D: 16.5</p>	 <p>0 77924 03549 4</p>
7175	GRILL COVER	 <ul style="list-style-type: none"> <li>• Breathable and water resistant to help protect grill from rusting</li> <li>• Fastening strap keeps the cover in place</li> <li>• Fits 18 inch <b>WEBER</b> charcoal grills</li> </ul>	<p>\$29.99      \$31.99</p> <p><b>MASTER CARTON: 5</b></p> <p>H: 9.88    W: 7.44    D: 8.88    Wt: 5.00    Cu.Ft.: 0.37</p> <p><b>INDIVIDUAL CARTON:</b></p> <p>H: 9.07    W: 6.63    D: 1.50    Wt: 0.60</p> <p><b>OUT OF CARTON:</b></p> <p>H: 32      W: 18.5    D: 24</p>	 <p>0 77924 04814 2</p>
7176	GRILL COVER	 <ul style="list-style-type: none"> <li>• Breathable and water resistant to help protect grill from rusting</li> <li>• Fastening strap keeps the cover in place</li> <li>• Fits 22 inch <b>WEBER</b> charcoal grills</li> </ul>	<p>\$32.99      \$35.99</p> <p><b>MASTER CARTON: 5</b></p> <p>H: 9.88    W: 7.44    D: 8.88    Wt: 6.00    Cu.Ft.: 0.37</p> <p><b>INDIVIDUAL CARTON:</b></p> <p>H: 9.07    W: 6.63    D: 1.50    Wt: 0.80</p> <p><b>OUT OF CARTON:</b></p> <p>H: 35      W: 23.5    D: 28.5</p>	 <p>0 77924 04815 9</p>
7148	PREMIUM GRILL COVER	 <ul style="list-style-type: none"> <li>• UV inhibitors in fabric resist fading</li> <li>• Breathable and water resistant to help protect grill from the elements</li> <li>• Fastening strap keeps the cover in place</li> <li>• Fits 18 inch <b>WEBER</b> charcoal grills</li> </ul>	<p>\$49.99      \$54.99</p> <p><b>MASTER CARTON: 4</b></p> <p>H: 10.63    W: 8.13    D: 9.00    Wt: 4.70    Cu.Ft.: 0.45</p> <p><b>INDIVIDUAL CARTON:</b></p> <p>H: 9.75    W: 7.25    D: 1.94    Wt: 0.92</p> <p><b>OUT OF CARTON:</b></p> <p>H: 32.5    W: 20      D: 20.5</p>	 <p>0 77924 03272 1</p>
7150	PREMIUM GRILL COVER	 <ul style="list-style-type: none"> <li>• UV inhibitors in fabric resist fading</li> <li>• Breathable and water resistant to help protect grill from the elements</li> <li>• Fastening strap keeps the cover in place</li> <li>• Fits 22 inch <b>WEBER</b> charcoal grills</li> </ul>	<p>\$58.99      \$65.99</p> <p><b>MASTER CARTON: 4</b></p> <p>H: 10.63    W: 8.13    D: 11.69    Wt: 6.08    Cu.Ft.: 0.58</p> <p><b>INDIVIDUAL CARTON:</b></p> <p>H: 9.75    W: 7.25    D: 2.63    Wt: 1.16</p> <p><b>OUT OF CARTON:</b></p> <p>H: 35      W: 27      D: 25</p>	 <p>0 77924 03278 3</p>
7151	PREMIUM GRILL COVER	 <ul style="list-style-type: none"> <li>• UV inhibitors in fabric resist fading</li> <li>• Breathable and water resistant to help protect grill from the elements</li> <li>• Fastening strap keeps the cover in place</li> <li>• Fits <b>PERFORMER</b> 22 inch charcoal grills with folding table</li> </ul>	<p>\$87.99      \$98.99</p> <p><b>MASTER CARTON: 3</b></p> <p>H: 10.63    W: 8.13    D: 9.00    Wt: 5.54    Cu.Ft.: 0.45</p> <p><b>INDIVIDUAL CARTON:</b></p> <p>H: 11.25    W: 7.25    D: 2.75    Wt: 1.52</p> <p><b>OUT OF CARTON:</b></p> <p>H: 42      W: 40      D: 33</p>	 <p>0 77924 03280 6</p>



# ACCESSORIES



MAP



MSRP

## CARE: COVERS - CHARCOAL GRILL



<b>7152</b>	<b>PREMIUM GRILL COVER</b>		\$104.99	\$115.99	 0 77924 03281 3		
	<ul style="list-style-type: none"> <li>• UV inhibitors in fabric resist fading</li> <li>• Breathable and water resistant to help protect grill from the elements</li> <li>• Fastening strap keeps the cover in place</li> <li>• Fits <b>PERFORMER</b> Premium and Deluxe 22 inch charcoal grills</li> </ul>	<b>MASTER CARTON: 3</b>					
		<b>H:</b> 10.63	<b>W:</b> 8.13	<b>D:</b> 9.00		<b>Wt:</b> 6.20	<b>Cu.Ft.:</b> 0.45
		<b>INDIVIDUAL CARTON:</b>					
		<b>H:</b> 11.25	<b>W:</b> 7.25	<b>D:</b> 2.65	<b>Wt:</b> 1.68		
		<b>OUT OF CARTON:</b>					
		<b>H:</b> 46.7	<b>W:</b> 48.5	<b>D:</b> 39.8			



<b>7153</b>	<b>PREMIUM GRILL COVER</b>		\$87.99	\$98.99	 0 77924 03283 7		
	<ul style="list-style-type: none"> <li>• UV inhibitors in fabric resist fading</li> <li>• Breathable and water resistant to help protect grill from the elements</li> <li>• Fastening strap keeps the cover in place</li> <li>• Fits 26 inch <b>WEBER</b> charcoal grills</li> </ul>	<b>MASTER CARTON: 2</b>					
		<b>H:</b> 10.63	<b>W:</b> 8.13	<b>D:</b> 6.26		<b>Wt:</b> 3.92	<b>Cu.Ft.:</b> 0.31
		<b>INDIVIDUAL CARTON:</b>					
		<b>H:</b> 11.25	<b>W:</b> 7.25	<b>D:</b> 2.65	<b>Wt:</b> 1.30		
		<b>OUT OF CARTON:</b>					
		<b>H:</b> 39	<b>W:</b> 31.5	<b>D:</b> 31.5			

<b>7173</b>	<b>PREMIUM GRILL COVER</b>		\$104.99	\$115.99	 0 77924 04165 5		
	<ul style="list-style-type: none"> <li>• UV inhibitors in fabric resist fading</li> <li>• Breathable and water resistant to help protect grill from the elements</li> <li>• Fastening strap keeps the cover in place</li> <li>• Fits <b>SUMMIT</b> Kamado E6 grill and <b>SUMMIT</b> charcoal grill</li> </ul>	<b>MASTER CARTON: 2</b>					
		<b>H:</b> 10.63	<b>W:</b> 8.13	<b>D:</b> 6.26		<b>Wt:</b> 4.21	<b>Cu.Ft.:</b> 0.31
		<b>INDIVIDUAL CARTON:</b>					
		<b>H:</b> 11.25	<b>W:</b> 7.25	<b>D:</b> 2.65	<b>Wt:</b> 1.69		
		<b>OUT OF CARTON:</b>					
		<b>H:</b> 43	<b>W:</b> 35.8	<b>D:</b> 34			











<b>7174</b>	<b>PREMIUM GRILL COVER</b>		\$115.99	\$126.99	 0 77924 04175 4		
	<ul style="list-style-type: none"> <li>• UV inhibitors in fabric resist fading</li> <li>• Breathable and water resistant to help protect grill from the elements</li> <li>• Fastening strap keeps the cover in place</li> <li>• Fits <b>SUMMIT</b> Kamado S6 charcoal grill and <b>SUMMIT</b> Grill Center charcoal grill</li> </ul>	<b>MASTER CARTON: 2</b>					
		<b>H:</b> 10.63	<b>W:</b> 8.13	<b>D:</b> 9.00		<b>Wt:</b> 6.08	<b>Cu.Ft.:</b> 0.45
		<b>INDIVIDUAL CARTON:</b>					
		<b>H:</b> 11.25	<b>W:</b> 7.25	<b>D:</b> 4.00	<b>Wt:</b> 2.19		
		<b>OUT OF CARTON:</b>					
		<b>H:</b> 44.5	<b>W:</b> 53	<b>D:</b> 36			

## CARE: COVERS - ELECTRIC

<b>7197</b>	<b>PREMIUM GRILL COVER</b>	<b>Available Dec 2022</b>	\$59.99	\$64.99	 0 77924 19530 3		
 <b>NEW</b>	<ul style="list-style-type: none"> <li>• Fits <b>LUMIN/LUMIN</b> Compact electric grill without stand</li> <li>• Resists fading with UV-inhibiting fabric</li> <li>• Shields grill from rain and snow with weather-resistant fabric</li> <li>• Secures in place with 2 drawstring pulls</li> </ul>	<b>MASTER CARTON: 4</b>					
		<b>H:</b> 4.65	<b>W:</b> 10.95	<b>D:</b> 9.5		<b>Wt:</b> 2.65	<b>Cu.Ft.:</b> 0.28
		<b>INDIVIDUAL CARTON:</b>					
		<b>H:</b> 7.5	<b>W:</b> 3.95	<b>D:</b> 2.5	<b>Wt:</b> 0.45		
		<b>OUT OF CARTON:</b>					
		<b>H:</b> 10.5	<b>W:</b> 20.3	<b>D:</b> 18.5			

<b>7196</b>	<b>PREMIUM GRILL COVER</b>	<b>Available Feb 2023</b>	\$109.99	\$119.99	 0 77924 19529 7		
 <b>NEW</b>	<ul style="list-style-type: none"> <li>• Fits <b>LUMIN/LUMIN</b> Compact electric grill on the stand</li> <li>• Resists fading with UV-inhibiting fabric</li> <li>• Shields grill from rain and snow with weather-resistant fabric</li> <li>• Secures in place with 4 fastening straps that connect to stand</li> </ul>	<b>MASTER CARTON: 5</b>					
		<b>H:</b> 13.5	<b>W:</b> 7.5	<b>D:</b> 9.8		<b>Wt:</b> 9.8	<b>Cu.Ft.:</b> 0.57
		<b>INDIVIDUAL CARTON:</b>					
		<b>H:</b> 10.5	<b>W:</b> 6.65	<b>D:</b> 2.45	<b>Wt:</b> 1.95		
		<b>OUT OF CARTON:</b>					
		<b>H:</b> 30.5	<b>W:</b> 23.5	<b>D:</b> 23.5			

## CARE: REPLACEMENT PARTS









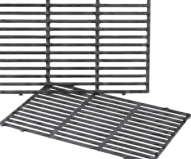

6501	WEBER Q ADAPTER HOSE		\$48.99	\$53.99	 0 77924 07501 8
 <ul style="list-style-type: none"> <li>Connects to a Type I (791) cylinder connection on a 20 lb. LP tank</li> <li>Fits Baby Q gas grill, <b>WEBER Q</b> 100/1000 series grills, <b>WEBER Q</b> gas grill, WEBER Q 200/2000 series grills and <b>WEBER TRAVELER</b> gas grill</li> </ul>			<b>MASTER CARTON: 4</b> H: 10.32 W: 8.44 D: 13.50 Wt: 6.00 Cu.Ft.: 0.68		
			<b>INDIVIDUAL CARTON:</b> H: 9.25 W: 7.50 D: 3.00 Wt: 1.50		
			<b>OUT OF CARTON:</b> H: 6.8 W: 1.5 D: 0.5		
7644	COOKING GRATES		\$109.99	\$120.99	 0 77924 03883 9
 <ul style="list-style-type: none"> <li>Porcelain-enameled, cast-iron cooking grates</li> <li>Includes bracket support for <b>WEBER Q</b> 100 series gas grills</li> <li>Fits <b>WEBER Q</b> 100/1000 series gas grills</li> </ul>			<b>MASTER CARTON: 1</b> H: 1.25 W: 20.88 D: 16.00 Wt: 11.30 Cu.Ft.: 0.24		
			<b>INDIVIDUAL CARTON:</b> H: 16.00 W: 20.88 D: 1.25 Wt: 11.30		
			<b>OUT OF CARTON:</b> H: 17 W: 12.7 D: 0.5		
7645	COOKING GRATES		\$120.99	\$131.99	 0 77924 03884 6
 <ul style="list-style-type: none"> <li>Porcelain-enameled, cast-iron cooking grates</li> <li>Includes bracket support for <b>WEBER Q</b> 200 series gas grills</li> <li>Fits <b>WEBER Q</b> 200/2000 series gas grills</li> </ul>			<b>MASTER CARTON: 1</b> H: 1.25 W: 25.38 D: 18.63 Wt: 17.53 Cu.Ft.: 0.34		
			<b>INDIVIDUAL CARTON:</b> H: 18.63 W: 25.38 D: 1.25 Wt: 17.53		
			<b>OUT OF CARTON:</b> H: 21.5 W: 15.3 D: 0.5		
7646	COOKING GRATES		\$131.99	\$142.99	 0 77924 03885 3
 <ul style="list-style-type: none"> <li>Porcelain-enameled, cast-iron cooking grates</li> <li>Fits <b>WEBER Q</b> 300/3000 series gas grills</li> </ul>			<b>MASTER CARTON: 1</b> H: 2.13 W: 21.88 D: 16.38 Wt: 20.30 Cu.Ft.: 0.44		
			<b>INDIVIDUAL CARTON:</b> H: 16.38 W: 21.88 D: 2.13 Wt: 20.30		
			<b>OUT OF CARTON:</b> H: 25 W: 17.8 D: 0.5		
6414	REPLACEMENT CASTER		\$21.99	\$24.99	 0 77924 07474 5
 <p>Fits the following grills:</p> <ul style="list-style-type: none"> <li><b>GENESIS</b> 1000-5000</li> <li><b>GENESIS</b> A/B/C (2002-2003 model years)</li> <li><b>GENESIS</b> Gold B/C (model year 2002 and newer)</li> <li>Platinum I</li> <li><b>RANCH</b> kettle</li> <li><b>PERFORMER</b> (prior to 2005 model year)</li> </ul>			<b>MASTER CARTON: 6</b> H: 6.94 W: 6.44 D: 9.57 Wt: 1.98 Cu.Ft.: 0.24		
			<b>INDIVIDUAL CARTON:</b> H: 6.10 W: 2.75 D: 2.75 Wt: 0.33		
			<b>OUT OF CARTON:</b> H: 2.5 W: 1.5 D: 4.6		

# ACCESSORIES

MAP

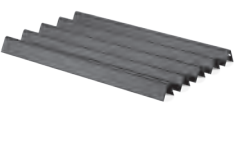











MSRP

## CARE: REPLACEMENT PARTS - GAS GRILL

7639	GAS GRILL COOKING GRATES	\$164.99	\$175.99		
	<ul style="list-style-type: none"> <li>• Stainless steel cooking grates</li> <li>• Fits <b>SPIRIT</b> 300 series gas grills</li> <li>• Does not fit <b>SPIRIT II</b> 300 series gas grills</li> </ul>	<b>MASTER CARTON: 1</b>			
		H: 1.38 W: 20.25 D: 14.07 Wt: 11.12 Cu.Ft.: 0.22			
		<b>INDIVIDUAL CARTON:</b>			
		H: 14.07 W: 20.25 D: 1.38 Wt: 11.12			
<b>OUT OF CARTON:</b>			0 77924 03222 6		
H: 17.3 W: 11.8 D: 0.5					
7524	GAS GRILL COOKING GRATES	\$138.99	\$153.99		
	<ul style="list-style-type: none"> <li>• Porcelain-enameled, cast-iron cooking grates</li> <li>• Fits <b>GENESIS</b> 300 series gas grills</li> <li>• Does not fit <b>GENESIS II</b> 300 series gas grills</li> </ul>	<b>MASTER CARTON: 1</b>			
		H: 2.38 W: 23.07 D: 16.63 Wt: 17.30 Cu.Ft.: 0.52			
		<b>INDIVIDUAL CARTON:</b>			
		H: 16.63 W: 23.07 D: 2.38 Wt: 17.30			
<b>OUT OF CARTON:</b>			0 77924 07437 0		
H: 19.5 W: 12.9 D: 0.5					
7528	GAS GRILL COOKING GRATES	\$230.99	\$252.99		
	<ul style="list-style-type: none"> <li>• Stainless steel cooking grates</li> <li>• Fits <b>GENESIS</b> 300 series gas grills</li> <li>• Does not fit <b>GENESIS II</b> 300 series gas grills</li> </ul>	<b>MASTER CARTON: 1</b>			
		H: 2.00 W: 22.11 D: 16.07 Wt: 14.10 Cu.Ft.: 0.41			
		<b>INDIVIDUAL CARTON:</b>			
		H: 16.07 W: 22.11 D: 2.00 Wt: 14.10			
<b>OUT OF CARTON:</b>			0 77924 07441 7		
H: 19.5 W: 12.9 D: 0.6					
7534	FLAVORIZER BARS	\$67.99	\$72.99		
	<ul style="list-style-type: none"> <li>• Porcelain-enameled</li> <li>• Catch drippings that smoke and sizzle, adding a smoky flavour to food</li> <li>• Set of five bars</li> <li>• Fits <b>SPIRIT</b> 200 series (with side-mounted control panel), <b>SPIRIT</b> 500, and <b>GENESIS Silver A</b></li> </ul>	<b>MASTER CARTON: 1</b>			
		H: 3.25 W: 25.50 D: 5.50 Wt: 6.00 Cu.Ft.: 0.26			
		<b>INDIVIDUAL CARTON:</b>			
		H: 5.50 W: 25.50 D: 3.25 Wt: 6.00			
<b>OUT OF CARTON:</b>			0 77924 07447 9		
H: 21.5 W: 1.7 D: 1.7					
7536	FLAVORIZER BARS	\$72.99	\$83.99		
	<ul style="list-style-type: none"> <li>• Porcelain-enameled</li> <li>• Catch drippings that smoke and sizzle, adding a smoky flavour to food</li> <li>• Set of five bars</li> <li>• Fits <b>SPIRIT</b> 300 series gas grills (with side-mounted control panel)</li> </ul>	<b>MASTER CARTON: 1</b>			
		H: 3.25 W: 25.50 D: 5.50 Wt: 7.00 Cu.Ft.: 0.26			
		<b>INDIVIDUAL CARTON:</b>			
		H: 5.50 W: 25.50 D: 3.25 Wt: 7.00			
<b>OUT OF CARTON:</b>			0 77924 07449 3		
H: 22.5 W: 2.3 D: 2.3					
7635	FLAVORIZER BARS	\$65.99	\$71.99		
	<ul style="list-style-type: none"> <li>• Porcelain-enameled</li> <li>• Catch drippings that smoke and sizzle, adding a smoky flavour to food</li> <li>• Set of three bars</li> <li>• Fits <b>SPIRIT</b> 200 series gas grills (with front-mounted control panel)</li> </ul>	<b>MASTER CARTON: 1</b>			
		H: 5.75 W: 17.50 D: 5.00 Wt: 3.94 Cu.Ft.: 0.29			
		<b>INDIVIDUAL CARTON:</b>			
		H: 5.75 W: 17.50 D: 5.00 Wt: 3.94			
<b>OUT OF CARTON:</b>			0 77924 03216 5		
H: 15.3 W: 3.5 D: 2.5					



## CARE: REPLACEMENT PARTS - GAS GRILL



7636	FLAVORIZER BARS	 <ul style="list-style-type: none"> <li>• Porcelain-enameled</li> <li>• Catch drippings that smoke and sizzle, adding a smoky flavour to food</li> <li>• Set of five bars</li> <li>• Fits SPIRIT 300 series gas grills (with front-mounted control panel)</li> </ul>	<p>\$84.99      \$95.99</p> <p><b>MASTER CARTON: 1</b> H: 5.75    W: 17.50    D: 5.00    Wt: 3.94    Cu.Ft.: 0.29</p> <p><b>INDIVIDUAL CARTON:</b> H: 5.75    W: 17.50    D: 5.00    Wt: 3.94</p> <p><b>OUT OF CARTON:</b> H: 15.3    W: 2.6      D: 2.5</p>	 <p>0 77924 03217 2</p>
7539	FLAVORIZER BARS	 <ul style="list-style-type: none"> <li>• Porcelain-enameled</li> <li>• Catch drippings that smoke and sizzle, adding a smoky flavour to food</li> <li>• Set of five bars</li> <li>• Fits GENESIS 300 series gas grills (with side-mounted control panel)</li> </ul>	<p>\$72.99      \$83.99</p> <p><b>MASTER CARTON: 1</b> H: 3.36    W: 25.88    D: 6.00    Wt: 9.10    Cu.Ft.: 0.30</p> <p><b>INDIVIDUAL CARTON:</b> H: 6.00    W: 25.88    D: 3.36    Wt: 9.10</p> <p><b>OUT OF CARTON:</b> H: 24.5    W: 2.2      D: 2.3</p>	 <p>0 77924 07452 3</p>
7621	FLAVORIZER BARS	 <ul style="list-style-type: none"> <li>• Porcelain-enameled</li> <li>• Catch drippings that smoke and sizzle, adding a smoky flavour to food</li> <li>• Set of five bars</li> <li>• Fits GENESIS 300 series gas grills (with front-mounted control panel)</li> <li>• Does not fit GENESIS II 300 series gas grills</li> </ul>	<p>\$72.99      \$83.99</p> <p><b>MASTER CARTON: 1</b> H: 3.44    W: 25.63    D: 5.88    Wt: 4.50    Cu.Ft.: 0.30</p> <p><b>INDIVIDUAL CARTON:</b> H: 5.88    W: 25.63    D: 3.44    Wt: 4.50</p> <p><b>OUT OF CARTON:</b> H: 17.6    W: 2.3      D: 2.2</p>	 <p>0 77924 02317 0</p>
7620	FLAVORIZER BARS	 <ul style="list-style-type: none"> <li>• Stainless steel</li> <li>• Catch drippings that smoke and sizzle, adding a smoky flavour to food</li> <li>• Set of five bars</li> <li>• Fits GENESIS 300 series gas grills (with front-mounted control panel)</li> <li>• Does not fit GENESIS II 300 series gas grills</li> </ul>	<p>\$164.99      \$186.99</p> <p><b>MASTER CARTON: 1</b> H: 3.44    W: 25.63    D: 5.88    Wt: 4.50    Cu.Ft.: 0.30</p> <p><b>INDIVIDUAL CARTON:</b> H: 5.88    W: 25.63    D: 3.44    Wt: 4.50</p> <p><b>OUT OF CARTON:</b> H: 17.5    W: 2.2      D: 2.3</p>	 <p>0 77924 02316 3</p>
7502	24 INCH HOSE AND REGULATOR KIT	 <p>Fits</p> <ul style="list-style-type: none"> <li>• GENESIS Silver C</li> <li>• GENESIS Gold B/C</li> <li>• GENESIS Platinum B/C</li> <li>• SUMMIT Silver/Gold/Platinum</li> </ul>	<p>\$47.99      \$51.99</p> <p><b>MASTER CARTON: 4</b> H: 10.32    W: 8.44    D: 13.57    Wt: 6      Cu.Ft.: 0.68</p> <p><b>INDIVIDUAL CARTON:</b> H: 9.25    W: 7.60    D: 3.10    Wt: 1.42</p> <p><b>OUT OF CARTON:</b> H: 21      W: 4      D: 0.5</p>	 <p>0 77924 07415 8</p>
7627	30 INCH HOSE AND REGULATOR KIT	 <ul style="list-style-type: none"> <li>• Fits GENESIS 300 series gas grills (front mounted control panel)</li> <li>• Fits SUMMIT 400/600 series gas grills</li> </ul>	<p>\$47.99      \$51.99</p> <p><b>MASTER CARTON: 4</b> H: 10.32    W: 8.44    D: 13.57    Wt: 6.54    Cu.Ft.: 0.68</p> <p><b>INDIVIDUAL CARTON:</b> H: 9.29    W: 7.54    D: 3.04    Wt: 1.64</p> <p><b>OUT OF CARTON:</b> H: 31.2    W: 4      D: 0.6</p>	 <p>0 77924 02328 6</p>



# ACCESSORIES



MAP



MSRP



## CARE: REPLACEMENT PARTS - GAS GRILL



<b>7507</b>	<b>STAINLESS STEEL BURNER TUBE SET</b>		\$76.99	\$84.99	 0 77924 07420 2		
	Fits the following gas grills: • SPIRIT 500 • GENESIS Silver A	<b>MASTER CARTON: 4</b>					
		H: 5.44	W: 31.75	D: 6.69		Wt: 12.31	Cu.Ft.: 0.66
		<b>INDIVIDUAL CARTON:</b>					
		H: 2.90	W: 30.10	D: 2.30		Wt: 2.50	
<b>OUT OF CARTON:</b>			H: 27	W: 1	D: 1		

<b>7508</b>	<b>STAINLESS STEEL BURNER TUBE SET</b>		\$93.99	\$104.99	 0 77924 07421 9		
	Fits the following gas grills: • SPIRIT 700 • GENESIS Silver B/C • GENESIS Gold (2002 and newer models)	<b>MASTER CARTON: 4</b>					
		H: 5.44	W: 31.75	D: 6.69		Wt: 13.20	Cu.Ft.: 0.66
		<b>INDIVIDUAL CARTON:</b>					
		H: 2.90	W: 30.10	D: 2.30		Wt: 3.30	
<b>OUT OF CARTON:</b>			H: 28	W: 1	D: 1		









<b>7509</b>	<b>IGNITER KIT</b>		\$20.99	\$23.99	 0 77924 07422 6		
	Fits the following gas grills: • SPIRIT (does not fit front-mounted control panel models) • GENESIS (prior to 2002 model year) • Platinum I/II	<b>MASTER CARTON: 6</b>					
		H: 6.94	W: 6.44	D: 9.57		Wt: 1.10	Cu.Ft.: 0.24
		<b>INDIVIDUAL CARTON:</b>					
		H: 6.10	W: 2.75	D: 2.75		Wt: 0.35	
<b>OUT OF CARTON:</b>			H: 19.1	W: 1	D: 1		

<b>7510</b>	<b>IGNITER KIT</b>		\$20.99	\$23.99	 0 77924 07423 3		
	Fits the following gas grills: • GENESIS Silver/Gold/Platinum 2002 and newer (does not fit GENESIS Silver/Gold C models after 2003)	<b>MASTER CARTON: 6</b>					
		H: 6.94	W: 6.44	D: 9.57		Wt: 2.04	Cu.Ft.: 0.24
		<b>INDIVIDUAL CARTON:</b>					
		H: 6.10	W: 2.75	D: 2.75		Wt: 0.34	
<b>OUT OF CARTON:</b>			H: 7.5	W: 2.7	D: 2.7		

<b>7628</b>	<b>IGNITER KIT</b>		\$76.99	\$84.99	 0 77924 02329 3		
	• Battery included • Fits GENESIS 310 and 320 gas grills (with front-mounted control panel)	<b>MASTER CARTON: 6</b>					
		H: 8.88	W: 8.19	D: 9.44		Wt: 6.10	Cu.Ft.: 0.39
		<b>INDIVIDUAL CARTON:</b>					
		H: 8.00	W: 3.63	D: 2.75		Wt: 0.87	
<b>OUT OF CARTON:</b>			H: 3.3	W: 3.1	D: 2.4		

<b>7629</b>	<b>IGNITER KIT</b>		\$76.99	\$84.99	 0 77924 02330 9		
	• Battery included • Fits GENESIS 330 gas grill (with front-mounted control panel)	<b>MASTER CARTON: 6</b>					
		H: 8.88	W: 8.19	D: 9.44		Wt: 6.30	Cu.Ft.: 0.39
		<b>INDIVIDUAL CARTON:</b>					
		H: 8.00	W: 3.63	D: 2.80		Wt: 0.90	
<b>OUT OF CARTON:</b>			H: 3.2	W: 3.1	D: 2.3		

## CARE: REPLACEMENT PARTS - GAS GRILL









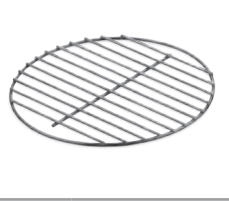

7642	IGNITER KIT		\$65.99	\$71.99	 0 77924 03223 3
 <ul style="list-style-type: none"> <li>• Battery included</li> <li>• Fits <b>SPIRIT</b> 210 and <b>SPIRIT</b> 310 gas grills (with front-mounted control panel)</li> </ul>		<b>MASTER CARTON: 6</b> H: 8.88 W: 8.19 D: 9.44 Wt: 5.22 Cu.Ft.: 0.39			
		<b>INDIVIDUAL CARTON:</b> H: 8.00 W: 3.63 D: 2.80 Wt: 0.72			
		<b>OUT OF CARTON:</b> H: 9.2 W: 3.6 D: 2.7			
7513	WARMING RACK		\$24.99	\$27.99	 0 77924 07426 4
 <p>Fits the following gas grills:</p> <ul style="list-style-type: none"> <li>• <b>SPIRIT</b> 700</li> <li>• <b>GENESIS</b> 1000-5500</li> <li>• <b>GENESIS</b> Silver B/C</li> <li>• <b>GENESIS</b> Gold/Platinum</li> <li>• Platinum I/II</li> </ul>		<b>MASTER CARTON: 4</b> H: 2.82 W: 26 D: 5.50 Wt: 7.00 Cu.Ft.: 0.23			
		<b>INDIVIDUAL CARTON:</b> H: 4.75 W: 24.80 D: 0.63 Wt: 1.42			
		<b>OUT OF CARTON:</b> H: 24.9 W: 4.7 D: 0.4			
7641	WARMING RACK		\$35.99	\$41.99	 0 77924 03294 3
 <ul style="list-style-type: none"> <li>• Keeps food warm while food grills below</li> <li>• Fits <b>SPIRIT</b> 300 series gas grills</li> </ul>		<b>MASTER CARTON: 4</b> H: 3.63 W: 26.25 D: 6.25 Wt: 6.32 Cu.Ft.: 0.34			
		<b>INDIVIDUAL CARTON:</b> H: 0.75 W: 26.00 D: 6.00 Wt: 1.50			
		<b>OUT OF CARTON:</b> H: 24.8 W: 4.6 D: 2.3			
7515	CATCH PAN AND HOLDER		\$49.99	\$54.99	 0 77924 07428 8
 <p>Fits the following gas grills:</p> <ul style="list-style-type: none"> <li>• <b>SPIRIT</b> (does not fit front-mounted control panel models)</li> <li>• <b>GENESIS</b> 1000-5500</li> <li>• <b>GENESIS</b> Silver/Gold/Platinum</li> <li>• Platinum I/II</li> <li>• <b>SUMMIT</b> (except Gold/Platinum 6-burner)</li> </ul>		<b>MASTER CARTON: 4</b> H: 10.32 W: 8.44 D: 13.57 Wt: 8.00 Cu.Ft.: 0.68			
		<b>INDIVIDUAL CARTON:</b> H: 9.50 W: 7.60 D: 3.10 Wt: 2.00			
		<b>OUT OF CARTON:</b> H: 9.1 W: 7.3 D: 3			

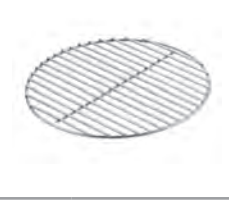
# ACCESSORIES



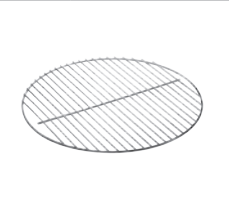



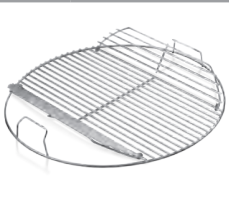

MAP

MSRP

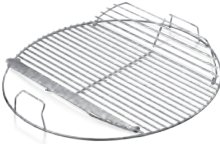

## CARE: REPLACEMENT PARTS - CHARCOAL GRILL

7439	CHARCOAL GRATE	Fits 14 inch <b>WEBER</b> charcoal grills	\$12.99	\$13.99	
			<b>MASTER CARTON: 5</b>		0 77924 07404 2
			H: 3.38 W: 11.86 D: 11.86 Wt: 5.00 Cu.Ft.: 0.26		
			<b>INDIVIDUAL CARTON:</b>		
			H: 10.63 W: 10.63 D: 0.63 Wt: 1.00		
			<b>OUT OF CARTON:</b>		
			H: 10.5 W: 10.5 D: 0.3		
7440	CHARCOAL GRATE	Fits 18 inch <b>WEBER</b> charcoal grills (does not fit <b>SMOKEY MOUNTAIN COOKER</b> smoker)	\$17.99	\$19.99	
			<b>MASTER CARTON: 5</b>		0 77924 07405 9
			H: 3.38 W: 15.07 D: 15.07 Wt: 9.78 Cu.Ft.: 0.44		
			<b>INDIVIDUAL CARTON:</b>		
			H: 13.63 W: 13.63 D: 0.63 Wt: 1.80		
			<b>OUT OF CARTON:</b>		
			H: 13.5 W: 13.5 D: 0.4		
7441	CHARCOAL GRATE	Fits 22 inch <b>WEBER</b> charcoal grills (does not fit <b>SMOKEY MOUNTAIN COOKER</b> smoker)	\$19.99	\$21.99	
			<b>MASTER CARTON: 5</b>		0 77924 07406 6
			H: 3.38 W: 19.25 D: 19.50 Wt: 17.22 Cu.Ft.: 0.73		
			<b>INDIVIDUAL CARTON:</b>		
			H: 18.00 W: 18 D: 0.63 Wt: 3.20		
			<b>OUT OF CARTON:</b>		
			H: 17 W: 17 D: 0.4		
7431	COOKING GRATE	Fits 14 inch <b>WEBER</b> charcoal grills (does not fit <b>SMOKEY MOUNTAIN COOKER</b> smoker)	\$16.99	\$18.99	
			<b>MASTER CARTON: 5</b>		0 77924 07396 0
			H: 3.38 W: 15.07 D: 15.07 Wt: 8.30 Cu.Ft.: 0.44		
			<b>INDIVIDUAL CARTON:</b>		
			H: 13.63 W: 13.63 D: 0.36 Wt: 1.37		
			<b>OUT OF CARTON:</b>		
			H: 13.7 W: 13.7 D: 0.3		
7432	COOKING GRATE	Fits 18 inch <b>WEBER</b> charcoal grills (does not fit <b>SMOKEY MOUNTAIN COOKER</b> smoker)	\$24.99	\$27.99	
			<b>MASTER CARTON: 5</b>		0 77924 07397 7
			H: 3.38 W: 19.25 D: 19.50 Wt: 16.00 Cu.Ft.: 0.73		
			<b>INDIVIDUAL CARTON:</b>		
			H: 17.50 W: 17.50 D: 2.25 Wt: 3.20		
			<b>OUT OF CARTON:</b>		
			H: 17.5 W: 17.5 D: 2		
7433	HINGED COOKING GRATE	Fits 18 inch <b>WEBER</b> charcoal grills (does not fit <b>SMOKEY MOUNTAIN COOKER</b> smoker)	\$29.99	\$31.99	
			<b>MASTER CARTON: 5</b>		0 77924 07398 4
			H: 3.38 W: 19.25 D: 19.50 Wt: 16.00 Cu.Ft.: 0.73		
			<b>INDIVIDUAL CARTON:</b>		
			H: 17.50 W: 17.50 D: 2.25 Wt: 3.20		
			<b>OUT OF CARTON:</b>		
			H: 17.2 W: 17.5 D: 1.7		

## CARE: REPLACEMENT PARTS - CHARCOAL GRILL

7435	COOKING GRATE	 <p>Fits 22 inch <b>WEBER</b> charcoal grills (does not fit <b>SMOKEY MOUNTAIN COOKER</b> smoker)</p>	<p>\$27.99      \$30.99</p> <p><b>MASTER CARTON: 5</b>  <b>H:</b> 3.38    <b>W:</b> 22.88    <b>D:</b> 22.88    <b>Wt:</b> 31.67    <b>Cu.Ft.:</b> 1.02</p> <p><b>INDIVIDUAL CARTON:</b>  <b>H:</b> 21.50    <b>W:</b> 21.50    <b>D:</b> 2.25    <b>Wt:</b> 6.00</p> <p><b>OUT OF CARTON:</b>  <b>H:</b> 21.5    <b>W:</b> 21.5    <b>D:</b> 2</p>	 <p>0 77924 07400 4</p>
7436	HINGED COOKING GRATE	 <p>Fits 22 inch <b>WEBER</b> charcoal grills (does not fit <b>SMOKEY MOUNTAIN COOKER</b> smoker)</p>	<p>\$36.99      \$40.99</p> <p><b>MASTER CARTON: 5</b>  <b>H:</b> 3.38    <b>W:</b> 22.88    <b>D:</b> 22.88    <b>Wt:</b> 26.22    <b>Cu.Ft.:</b> 1.02</p> <p><b>INDIVIDUAL CARTON:</b>  <b>H:</b> 21.50    <b>W:</b> 21.50    <b>D:</b> 1.75    <b>Wt:</b> 5.00</p> <p><b>OUT OF CARTON:</b>  <b>H:</b> 21.5    <b>W:</b> 21.5    <b>D:</b> 1.8</p>	 <p>0 77924 07401 1</p>
7444	22 INCH ONE-TOUCH CLEANING SYSTEM KIT	 <ul style="list-style-type: none"> <li>• Contains three damper blades, one damper control rod, one H-drive assembly, one washer, and an instruction sheet</li> <li>• Fits 22 inch <b>ONE-TOUCH</b>, 22 inch <b>ORIGINAL KETTLE</b>, and <b>PERFORMER</b> charcoal grills</li> </ul>	<p>\$29.99      \$31.99</p> <p><b>MASTER CARTON: 6</b>  <b>H:</b> 10.94    <b>W:</b> 4.94    <b>D:</b> 9.44    <b>Wt:</b> 5.80    <b>Cu.Ft.:</b> 0.29</p> <p><b>INDIVIDUAL CARTON:</b>  <b>H:</b> 10.10    <b>W:</b> 4.50    <b>D:</b> 1.50    <b>Wt:</b> 0.95</p> <p><b>OUT OF CARTON:</b>  <b>H:</b> 9.2    <b>W:</b> 1.6    <b>D:</b> 0.8</p>	 <p>0 77924 01097 2</p>
7478	KETTLE TOOL HOOK HANDLE	 <ul style="list-style-type: none"> <li>• Update your kettle with a new handle</li> <li>• Equipped with two tool hooks</li> </ul>	<p>\$18.99      \$20.99</p> <p><b>MASTER CARTON: 6</b>  <b>H:</b> 6.51    <b>W:</b> 8.13    <b>D:</b> 13.44    <b>Wt:</b> 2.10    <b>Cu.Ft.:</b> 0.41</p> <p><b>INDIVIDUAL CARTON:</b>  <b>H:</b> 5.55    <b>W:</b> 7.20    <b>D:</b> 1.88    <b>Wt:</b> 0.35</p> <p><b>OUT OF CARTON:</b>  <b>H:</b> 0.6    <b>W:</b> 1.2    <b>D:</b> 1.4</p>	 <p>0 77924 02283 8</p>

## MERCHANDISE: TOOL HOOKS



7401	TOOL HOOKS	 <ul style="list-style-type: none"> <li>• Hang essential grilling tools for easy access and organization of your backyard workspace</li> <li>• Fits 18 inch and 22 inch <b>WEBER</b> charcoal grills</li> </ul>	<p>\$9.99      \$11.99</p> <p><b>MASTER CARTON: 6</b>  <b>H:</b> 8.82    <b>W:</b> 8.19    <b>D:</b> 9.44    <b>Wt:</b> 2.17    <b>Cu.Ft.:</b> 0.39</p> <p><b>INDIVIDUAL CARTON:</b>  <b>H:</b> 8.00    <b>W:</b> 3.63    <b>D:</b> 2.75    <b>Wt:</b> 0.25</p> <p><b>OUT OF CARTON:</b>  <b>H:</b> 7    <b>W:</b> 2    <b>D:</b> 3.5</p>	 <p>0 77924 06864 5</p>
------	------------	--	---	--

# ACCESSORIES



MAP



MSRP



## MERCHANDISE: GRILL LIGHTS



<b>7661</b>	<b>GRILL 'N GO HANDLE LIGHT</b>		\$54.99	\$58.99			
	<ul style="list-style-type: none"> <li>• LED illuminates the entire cooking surface</li> <li>• Detachable to shine extra light where you need it</li> <li>• Motion sensor with an on/off switch saves battery life</li> <li>• Fits round handles on <b>WEBER SPIRIT, GENESIS</b> and <b>SUMMIT</b> gas grill models year 2007 and newer. Fits all <b>SPIRIT II, GENESIS II</b> grill models</li> <li>• Includes 3 AAA batteries / 20 hours</li> </ul>	<b>MASTER CARTON: 4</b>					
		<b>H: 5.83</b>	<b>W: 4.88</b>	<b>D: 8.07</b>		<b>Wt: 1.82</b>	<b>Cu.Ft.: 0.13</b>
		<b>INDIVIDUAL CARTON:</b>					
			<b>H: 4.53</b>	<b>W: 4.33</b>	<b>D: 1.78</b>	<b>Wt: 0.41</b>	
			<b>OUT OF CARTON:</b>				
			<b>H: 4.2</b>	<b>W: 2.5</b>	<b>D: 3</b>		

## MERCHANDISE: CARTS



<b>6618</b>	<b>LUMIN COMPACT STAND WITH SIDE TABLE</b>	<b>Available Dec 2022</b>	\$219.99	\$239.99			
	<ul style="list-style-type: none"> <li>• Collapsible design for simple setup, breakdown and storage</li> <li>• Built-in hooks to easily access grilling tools</li> <li>• Side table provides room to prep and serve</li> <li>• Durable, fade-resistant material maintains color and longevity</li> </ul>	<b>MASTER CARTON: 1</b>					
		<b>H: 19.8</b>	<b>W: 21.3</b>	<b>D: 10.0</b>		<b>Wt: 12.5</b>	<b>Cu.Ft.: 2.44</b>
		<b>INDIVIDUAL CARTON:</b>					
			<b>H: 19.8</b>	<b>W: 21.3</b>	<b>D: 10.0</b>	<b>Wt: 12.5</b>	
			<b>OUT OF CARTON:</b>				
			<b>H: 26.8</b>	<b>W: 21.6</b>	<b>D: 21.9</b>		



<b>6619</b>	<b>LUMIN STAND WITH SIDE TABLE</b>	<b>Available Dec 2022</b>	\$259.99	\$279.99			
	<ul style="list-style-type: none"> <li>• Collapsible design for simple setup, breakdown and storage</li> <li>• Built-in hooks to easily access grilling tools</li> <li>• Side table provides room to prep and serve</li> <li>• Durable, fade-resistant material maintains color and longevity</li> </ul>	<b>MASTER CARTON: 1</b>					
		<b>H: 21.35</b>	<b>W: 25.0</b>	<b>D: 10.35</b>		<b>Wt: 16.5</b>	<b>Cu.Ft.: 3.2</b>
		<b>INDIVIDUAL CARTON:</b>					
			<b>H: 21.15</b>	<b>W: 25.0</b>	<b>D: 10.3</b>	<b>Wt: 17.5</b>	
			<b>OUT OF CARTON:</b>				
			<b>H: 28.1</b>	<b>W: 25.0</b>	<b>D: 21.8</b>		

<b>6557</b>	<b>WEBER Q PORTABLE CART</b>		\$126.99	\$142.99			
	<ul style="list-style-type: none"> <li>• Grill attaches to cart and locks in place</li> <li>• Folds down while grill is attached for easy portability</li> <li>• Built-in wire transport handle</li> <li>• Fits <b>WEBER Q</b> 1000/2000 series grills</li> </ul>	<b>MASTER CARTON: 1</b>					
		<b>H: 4.20</b>	<b>W: 36.00</b>	<b>D: 22.00</b>		<b>Wt: 13.58</b>	<b>Cu.Ft.: 1.92</b>
		<b>INDIVIDUAL CARTON:</b>					
			<b>H: 22.00</b>	<b>W: 36.00</b>	<b>D: 4.20</b>	<b>Wt: 13.58</b>	
			<b>OUT OF CARTON H x W x D (EXCLUDES GRILL):</b>				
			<b>Raised (28.2 x 21 x 25) Collapsed (28.2 x 29.7 x 6.5)</b>				



<b>6525</b>	<b>WEBER Q CART</b>		\$186.99	\$208.99			
	<ul style="list-style-type: none"> <li>• Heavy-duty cart with three integrated tool hooks</li> <li>• Side handle for easy mobility</li> <li>• Storage area for tools and accessories</li> <li>• Screen discretely keeps 20 lb. LP tank out of view (tank not included)</li> <li>• Includes adapter hose for 20 lb. LP tank</li> <li>• Fits <b>WEBER Q</b> 2000 series grills</li> </ul>	<b>MASTER CARTON: 1</b>					
		<b>H: 8.82</b>	<b>W: 33.00</b>	<b>D: 19.13</b>		<b>Wt: 25.50</b>	<b>Cu.Ft.: 3.22</b>
		<b>INDIVIDUAL CARTON:</b>					
			<b>H: 19.13</b>	<b>W: 33.00</b>	<b>D: 8.82</b>	<b>Wt: 25.50</b>	
			<b>OUT OF CARTON (EXCLUDES GRILL):</b>				
			<b>H: 35.5</b>	<b>W: 21.5</b>	<b>D: 29.7</b>		



## MERCHANDISE: COOKBOOKS



209558		<b>WEBER'S ULTIMATE GRILLING</b>  <b>DISPLAYER</b> 1 displayer / 5 cookbooks		\$34.99 per book	<b>Master Carton:</b> 1	 0 77924 10072 7
					H: 9.75 W: 12.00 D: 12.07 Wt: 17.70 Cu.Ft.: 0.81	
					<b>Individual Book:</b>	
					H: 11.13 W: 8.75 D: 1.07 Wt: 0.04	

209557		<b>WEBER'S GREATEST HITS</b>  <b>DISPLAYER</b> 1 displayer / 5 cookbooks		\$29.99 per book	<b>Master Carton:</b> 1	 0 77924 05873 8
					H: 4.63 W: 9.57 D: 11.94 Wt: 13.38 Cu.Ft.: 0.30	
					<b>Individual Book:</b>	
					H: 11.38 W: 9.00 D: 0.75 Wt: 2.9	

209554		<b>WEBER'S NEW AMERICAN BARBECUE</b>  <b>DISPLAYER</b> 1 displayer / 5 cookbooks		\$34.99 per book	<b>Master Carton:</b> 1	 0 77924 04194 5
					H: 8.1 W: 9.8 D: 12 Wt: 13.3 Cu. Ft.: 0.55	

209553		<b>WEBER'S BIG BOOK OF BURGERS</b>  <b>DISPLAYER</b> 1 displayer / 5 cookbooks		\$29.95 per book	<b>Master Carton:</b> 1	 0 77924 03213 4
					H: 7.6 W: 9 D: 10 Wt: 9.4 Cu. Ft.: 0.4	

209552		<b>WEBER'S NEW REAL GRILLING</b>  <b>DISPLAYER</b> 1 displayer / 5 cookbooks		\$22.10 per book	<b>Master Carton:</b> 1	 0 77924 02102 2
					H: 8.1 W: 9.8 D: 12 Wt: 16.8 Cu. Ft.: 0.6	













202609		<b>WEBER'S WAY TO GRILL</b>  <b>DISPLAYER</b> 1 displayer / 5 cookbooks		\$34.95 per book	<b>Master Carton:</b> 1	 0 77924 01444 4
					H: 8.1 W: 9.8 D: 12 Wt: 15.5 Cu. Ft.: 0.5	

# ACCESSORIES

MAP

MSRP

## MERCHANDISE: CLEANERS

<p><b>8030</b> WEBER STUBBORN STAIN REMOVER 60Z - CAN</p>  <ul style="list-style-type: none"> <li>Removes stubborn stains on grill associated with grease, varnishing, and carbonization</li> <li>Safe on painted steel and porcelain-enamel</li> <li>Includes scratch-free applicator</li> </ul>	<p>\$17.99      \$19.99</p> <p><b>MASTER CARTON: 6</b>  <b>H: 8    W: 5.5    D: 7.5    Wt: 4    Cu.Ft.: 0.19</b></p> <p><b>INDIVIDUAL CARTON:</b>  <b>H: 7.25    W: 2    D: 2    Wt: 0.7</b></p>	 <p>0 77924 16356 2</p>
<p><b>8031</b> WEBER GRILL GRATE SCRUBBER - CAN</p>  <ul style="list-style-type: none"> <li>Designed for heavy-duty grill cleaning</li> <li>Contoured handle offers a firm, comfortable grip</li> <li>Includes 3 pads for quick and easy replacement</li> </ul>	<p>\$16.99      \$18.99</p> <p><b>MASTER CARTON: 6</b>  <b>H: 7.00    W: 5.40    D: 13.25    Wt: 2.00    Cu.Ft.: 0.29</b></p> <p><b>INDIVIDUAL CARTON:</b>  <b>H: 6.0    W: 3.0    D: 4.0    Wt: 0.25</b></p>	 <p>0 77924 16357 9</p>
<p><b>8032</b> WEBER GRATE GRILL CLEANER 160Z - CAN</p>  <ul style="list-style-type: none"> <li>Safe for your cooking grate surfaces</li> <li>Formula that is non-toxic and safe on skin</li> <li>Non-flammable, non-corrosive, biodegradable, and phosphate free</li> <li>Works on grills, smokers, ovens, microwaves, and more</li> </ul>	<p>\$16.99      \$18.99</p> <p><b>MASTER CARTON: 6</b>  <b>H: 11.50    W: 6.25    D: 8.25    Wt: 8.00    Cu.Ft.: 0.34</b></p> <p><b>INDIVIDUAL CARTON:</b>  <b>H: 10.85    W: 3.75    D: 2    Wt: 1.3</b></p>	 <p>0 77924 16358 6</p>
<p><b>8033</b> WEBER EXTERIOR GRILL CLEANER 160Z - CAN</p>  <ul style="list-style-type: none"> <li>Streak-free formula cleans exterior grill surfaces</li> <li>Removes water spots, grease, and grime</li> <li>Works great on painted steel, stainless steel, and porcelain-enamel surfaces</li> <li>Use with sponge, towel or high-quality paper towel</li> </ul>	<p>\$16.99      \$18.99</p> <p><b>MASTER CARTON: 6</b>  <b>H: 11.50    W: 6.25    D: 8.25    Wt: 8.00    Cu.Ft.: 0.34</b></p> <p><b>INDIVIDUAL CARTON:</b>  <b>H: 10.85    W: 3.75    D: 2    Wt: 1.3</b></p>	 <p>0 77924 16359 3</p>
<p><b>8034</b> 12 OZ. WEBER STAINLESS STEEL POLISH</p>  <p>Cleans, polishes, preserves and protects in one step without the need for hard rubbing. Resists fingerprints, grease, and water splatter, preserving the factory finish. Works great on your indoor stainless steel appliances, too! Meets all applicable emission codes and is Volatile Organic Compound Compliant. Fresh, clean citrus fragrance.</p>	<p>\$19.99      \$21.99</p> <p><b>MASTER CARTON: 6</b>  <b>H: 11.2    W: 8.3    D: 6.2    Wt: 6</b></p> <p><b>INDIVIDUAL CARTON:</b>  <b>H: 10    W: 2    D: 3.7    Wt: 1</b></p>	 <p>0 77924 16360 9</p>
<p><b>209940</b> WEBER CLEANER QUARTER PALLET</p>  <p>Contains            45 8033 EXTERIOR GRILL CLEANER            45 8031 GRATE GRILL SCRUBBER            45 8032 GRATE GRILL CLEANER</p>	<p>\$2,293.65</p> <p><b>JUST CARDBOARD QP</b>  <b>H: 46    W: 24    D: 20    Header H: 9</b></p> <p><b>TOTAL QP WITH HEADER</b>  <b>H: 60    W: 24    D: 20</b></p> <p><b>TOTAL QP WITH SHIPPING SHROUD</b>  <b>H: 52    W: 24    D: 20    Wt: 132</b></p>	 <p>8 30731 00087 7</p>



# HOW WE MEASURE

## GRILLS: OUT-OF-PACKAGE DIMENSIONS - FULLY ASSEMBLED

### HEIGHT

Vertical measurement

### WIDTH

Horizontal measurement

### DEPTH

Distance from front to back

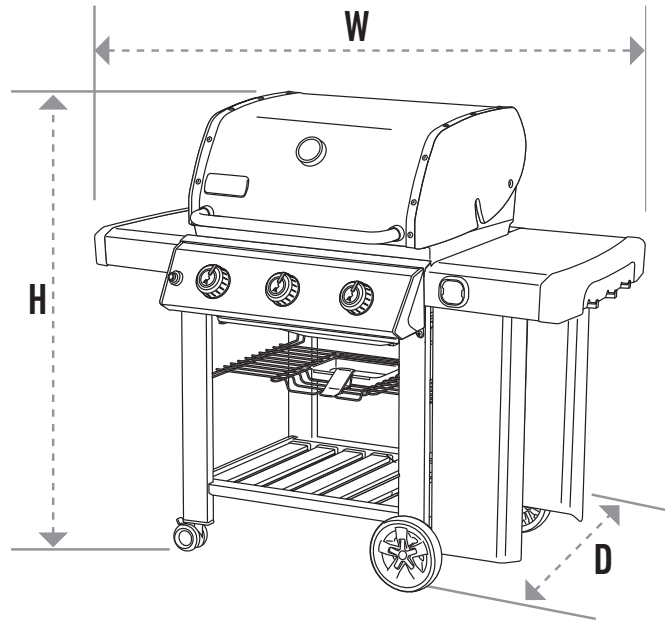

## ACCESSORIES: OUT-OF-PACKAGE DIMENSIONS - PRODUCT LAYING FLAT

### HEIGHT

Vertical measurement

### WIDTH

Horizontal measurement

### DEPTH

Distance from front to back

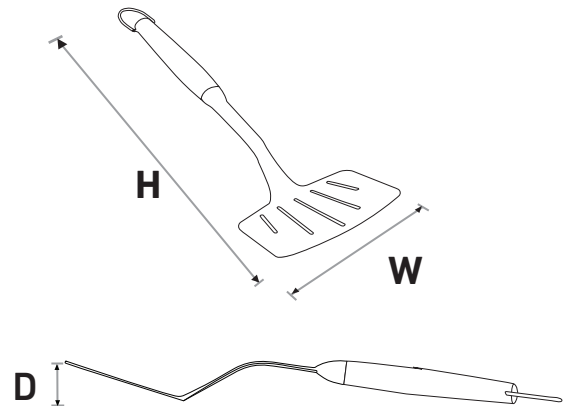
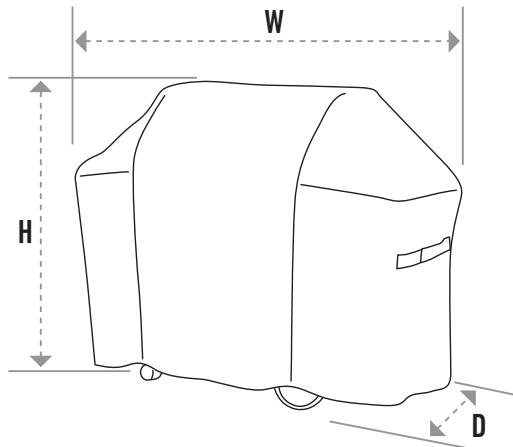

## ACCESSORIES: UNIT PACKAGE - UPRIGHT

### HEIGHT

Vertical measurement

### WIDTH

Horizontal measurement

### DEPTH

Distance from front to back

